

# Nokia Lumia 1020

## RM-877

### Key features

- 1.5 GHz Qualcomm dual-core processor
- 2 GB RAM and 32 GB of internal storage
- 4.5" AMOLED Puremotion HD+ display
- 41 Mpix PureView camera with OIS
- 2G / 3G / 4G LTE connectivity

Check the repair policy before performing any mechanical repair on Service Level 1&2!



Version 2.0

### Exploded view



### Disassembly steps

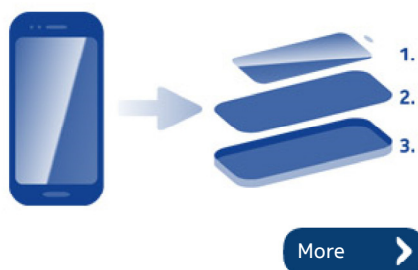

### Disassembly video



### Assembly steps

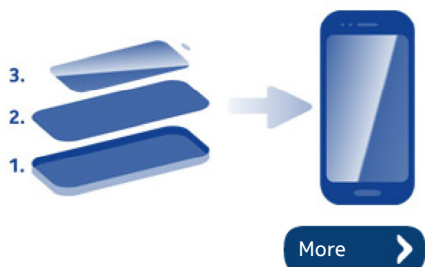

### Assembly video

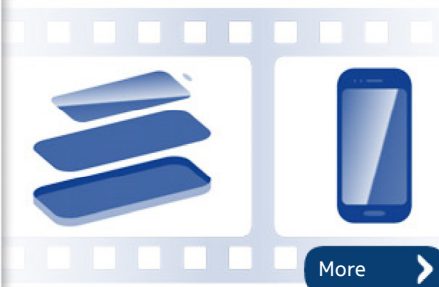

### Solder components

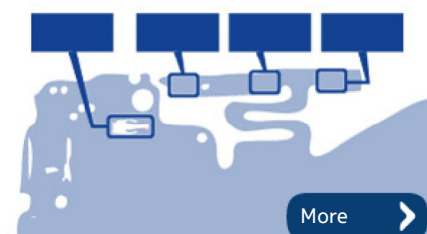

### Service devices

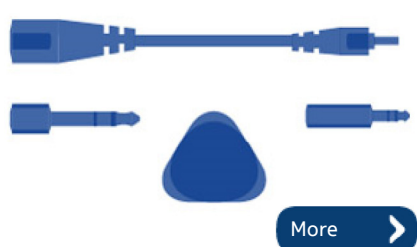

### Product controls and interfaces

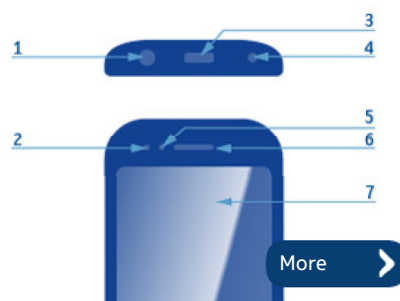

### Service concept

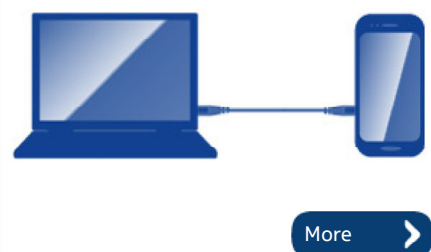

### Phone reset



**A1**

**WINDOW ASSEMBLY**  
(10001)

SENSOR SEALING TAPE  
10001



2ND CAMERA GASKET  
10013

2ND CAMERA ASSEMBLY  
10012



**A3**

**AV ASSEMBLY**  
(10005 - 10007)

EARPIECE  
10005

AV FRAME GROUNDING FOAM  
10006

SCREW TORX+ SIZE 5

EARPIECE HOLDER GASKET  
10007



BATTERY HOLDER ASSEMBLY  
10009

SCREW TORX+  
SIZE 5 M1.4 x 3.0  
10011

SCREW TORX+  
SIZE 6 M1.6 x 3.5  
10010

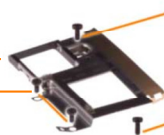

**A5**

**CAMERA ASSEMBLY**

2ND CAMERA GROUNDING PAD  
10003

**L3** WATER INGRESS LABEL

**L3** LIGHT SWAP PACKAGE  
(10002 - 10004) **A2**

LIGHT SWAP PWB  
10002

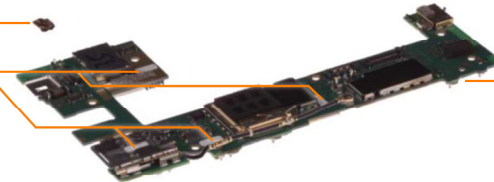

**L3** LABEL TRAY ASSEMBLY  
10018

**L3** TYPE LABEL  
10019



**A6**

**LOCKING RAIL ASSEMBLY**



**A4**

**BATTERY ASSEMBLY**  
(10008)

BATTERY GASKET  
10008



SCREW TORX+  
SIZE 4 M1.4 x 2.5  
10014

SIM TRAY  
10021

CAMERA DECO  
10016

USB GASKET  
10004 **A2**

BODY ASSEMBLY  
10020



XENON FLASH  
10015  
FLASH ADHESIVE  
10017

Only available as assembly

Not reusable after removal

**L3** Repair/swap only in level 3



1) For disassembling you need the Nokia Standard toolkit version 2. You will also need the SIM door key.



2) The power must be off during the disassembly procedure.



3) Protect the DISPLAY with protective film.



4) Release the SIM TRAY with the SIM door key.



5) Pull the SIM TRAY out.



6) Unscrew the TORX+ size 4 LOCKING RAIL SCREW. Open the screw 8 full turns.

Loosen the screw very slowly and be careful not to break the LOCKING RAIL ASSEMBLY.



7) Use the SRT-6 to detach the DISPLAY. Release the left side of the device by sliding the SRT-6 as shown.

Be careful not to damage any components or the flexes underneath the DISPLAY.



8) Carefully lift the left side of the DISPLAY to gain access to the connectors.

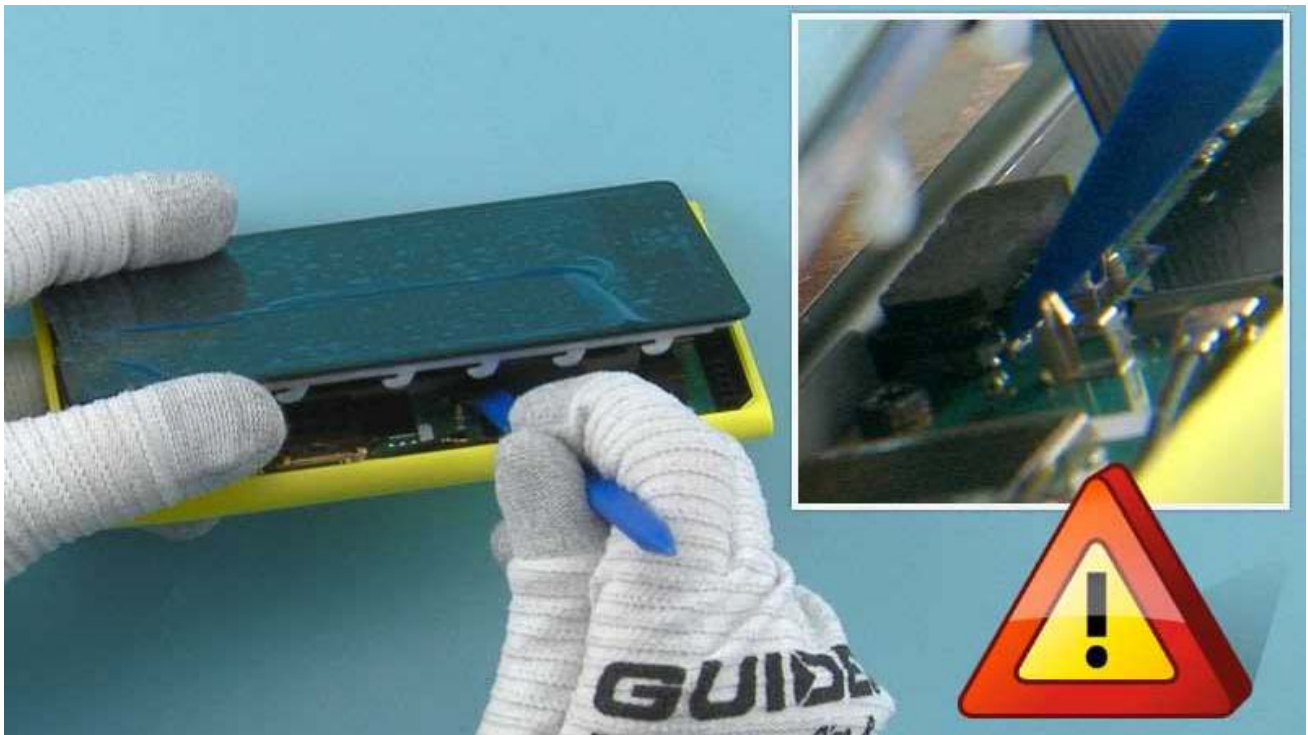

9) Use the SS-93 to open the BATTERY CONNECTOR.

Be careful not to damage the connector or any nearby components.

NOTE: The opening order of the connectors is mandatory to minimize the risk of battery current short circuits.



10) Use the SS-93 to open the 2nd CAMERA FLEX CONNECTOR.

Be careful not to damage the connector or any nearby components.



11) Use the SS-93 to open the DISPLAY CONNECTOR.

Be careful not to damage the connector or any nearby components.



12) The DISPLAY can now be separated.



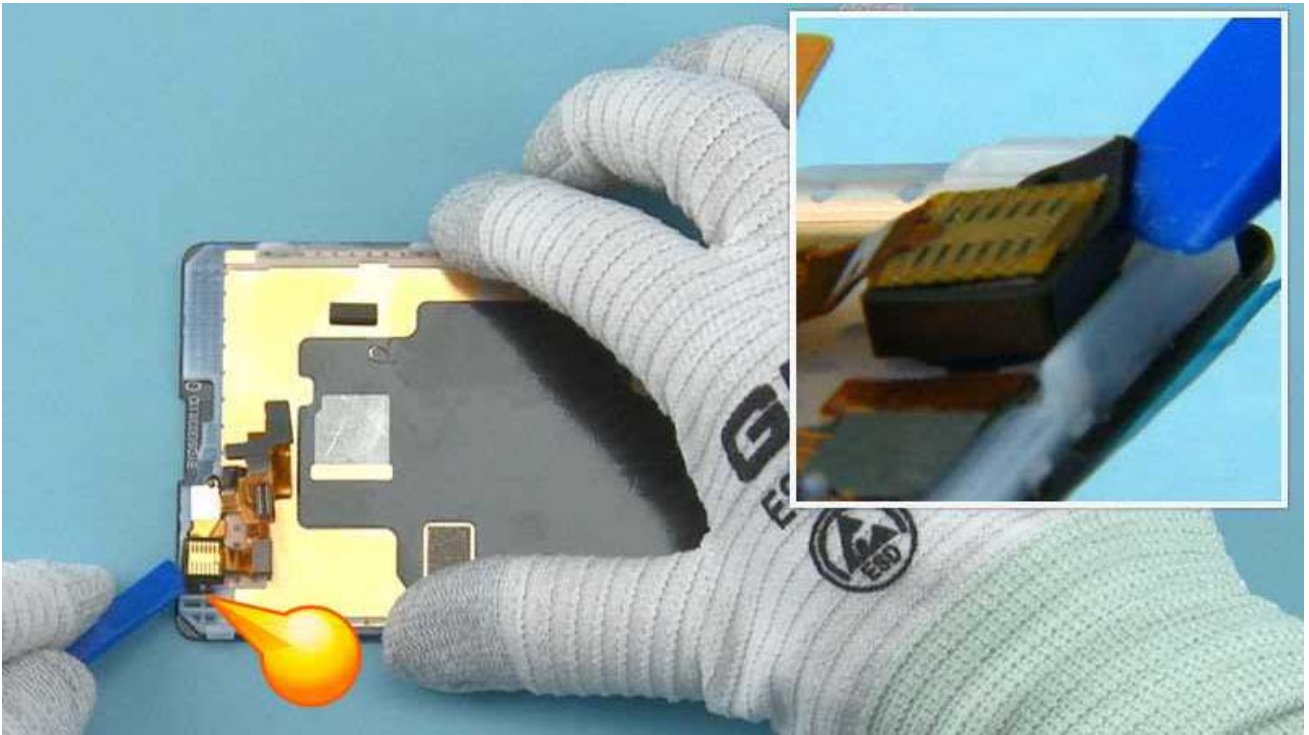

13) Start releasing the 2nd CAMERA ASSEMBLY with the SS-93 from the shown place.

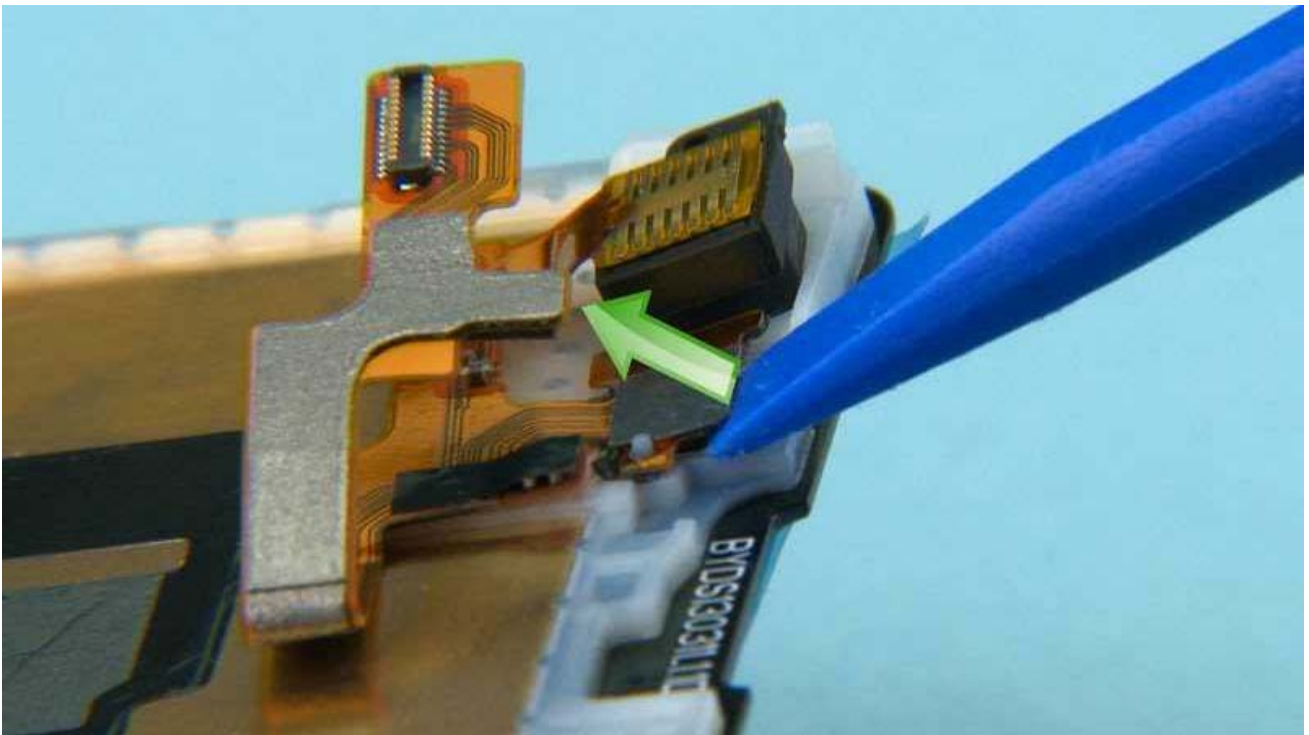

14) Detach the SENSOR by lifting it with the SS-93 as shown.

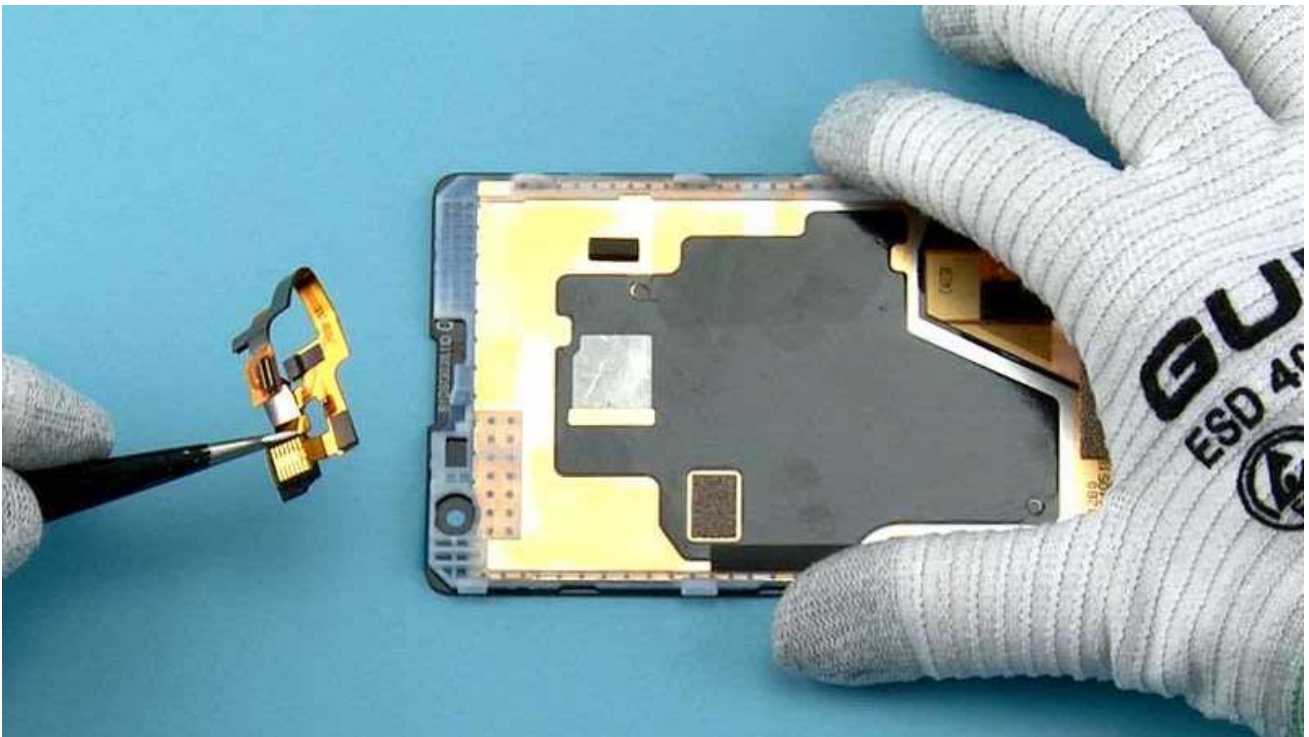

15) Remove the 2nd CAMERA ASSEMBLY with tweezers.

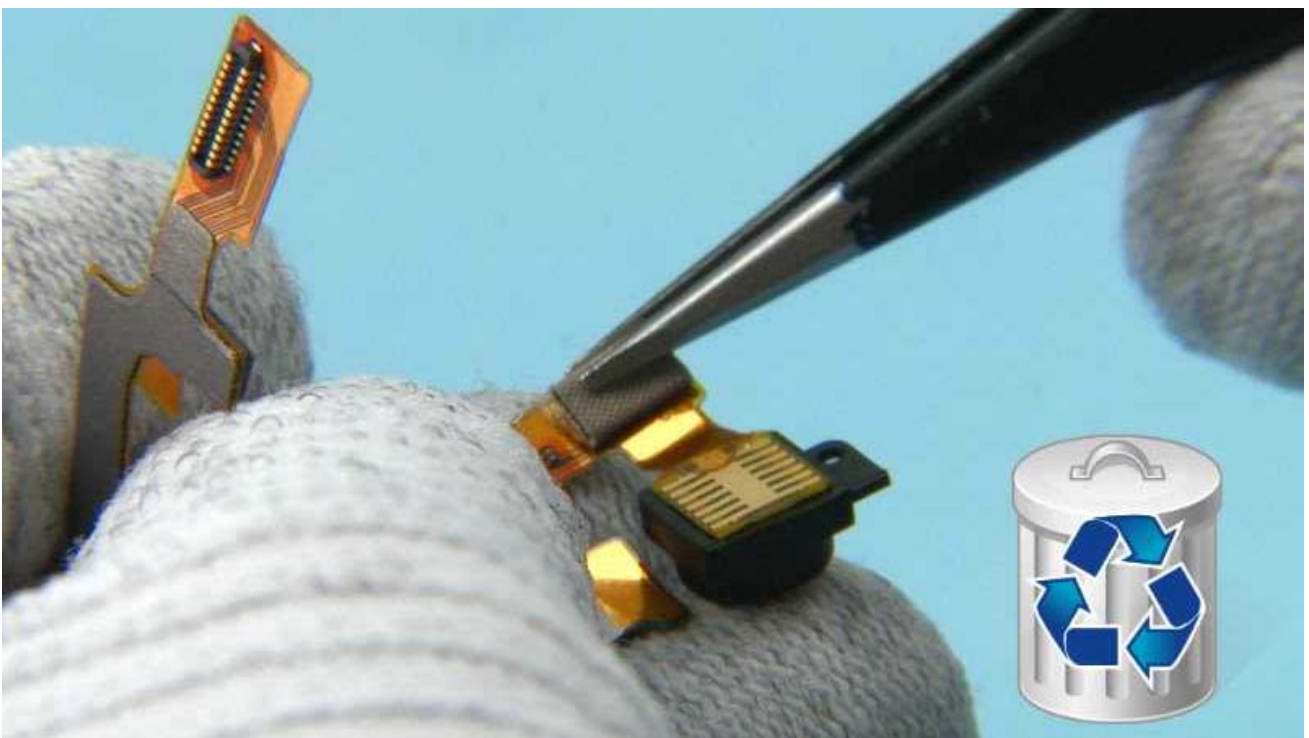

16) Use tweezers to remove the 2nd CAMERA GROUNDING FOAM. Do not use it again. Discard it.

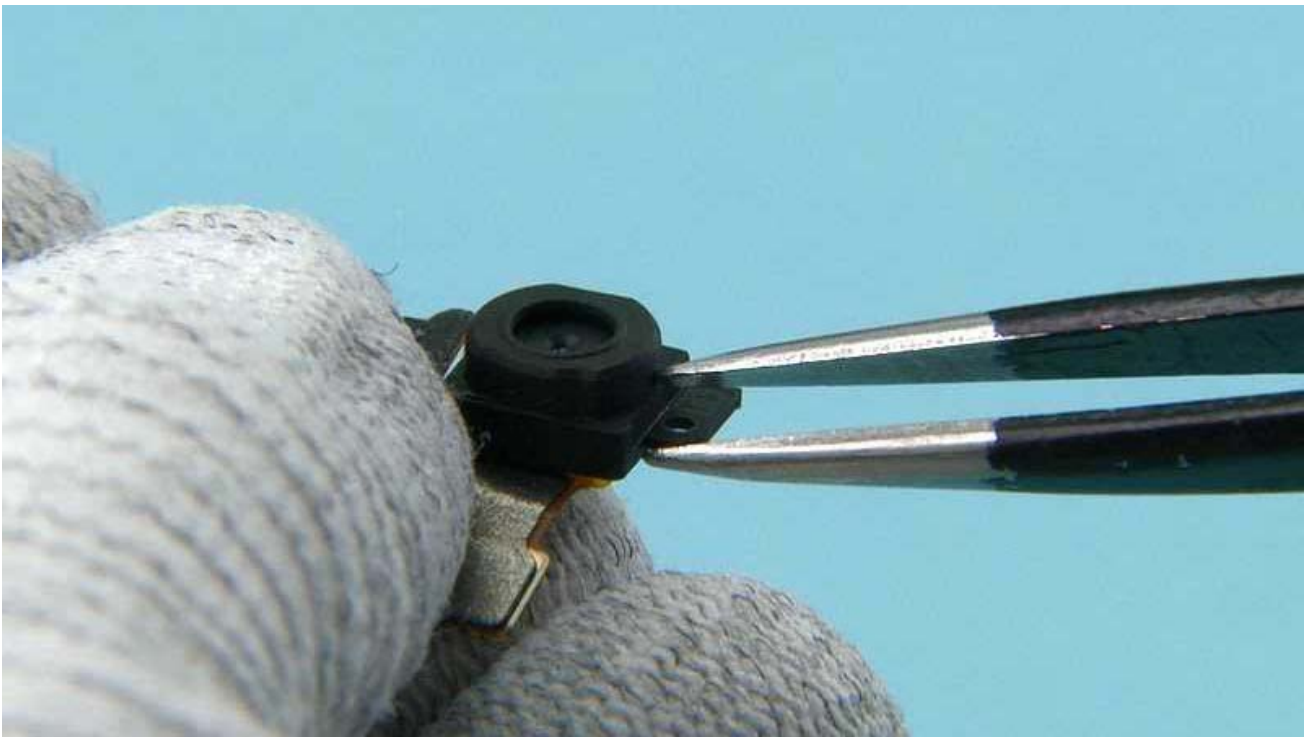

17) Use tweezers to detach the 2nd CAMERA GASKET.



18) Use the SS-93 to open the USB CONNECTOR.

Be careful not to damage the connector or any nearby components.

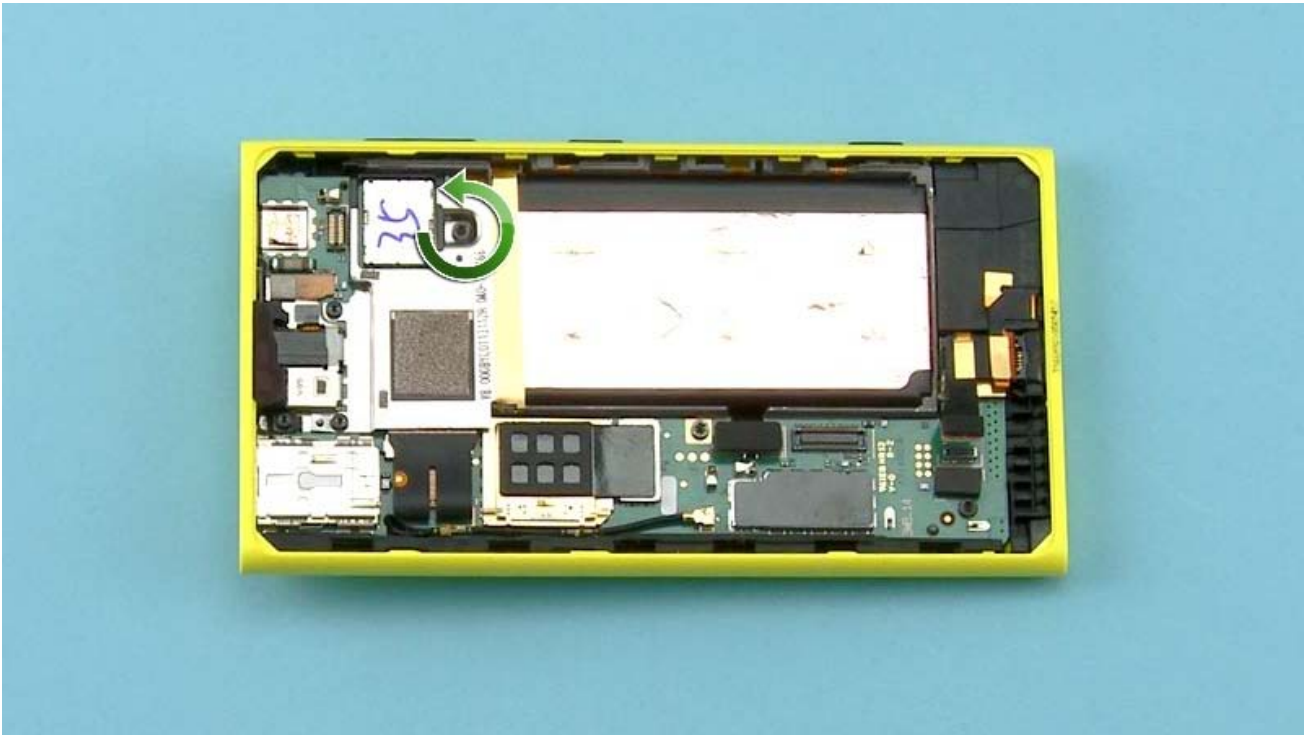

19) Unscrew this TORX+ size 6 screw.

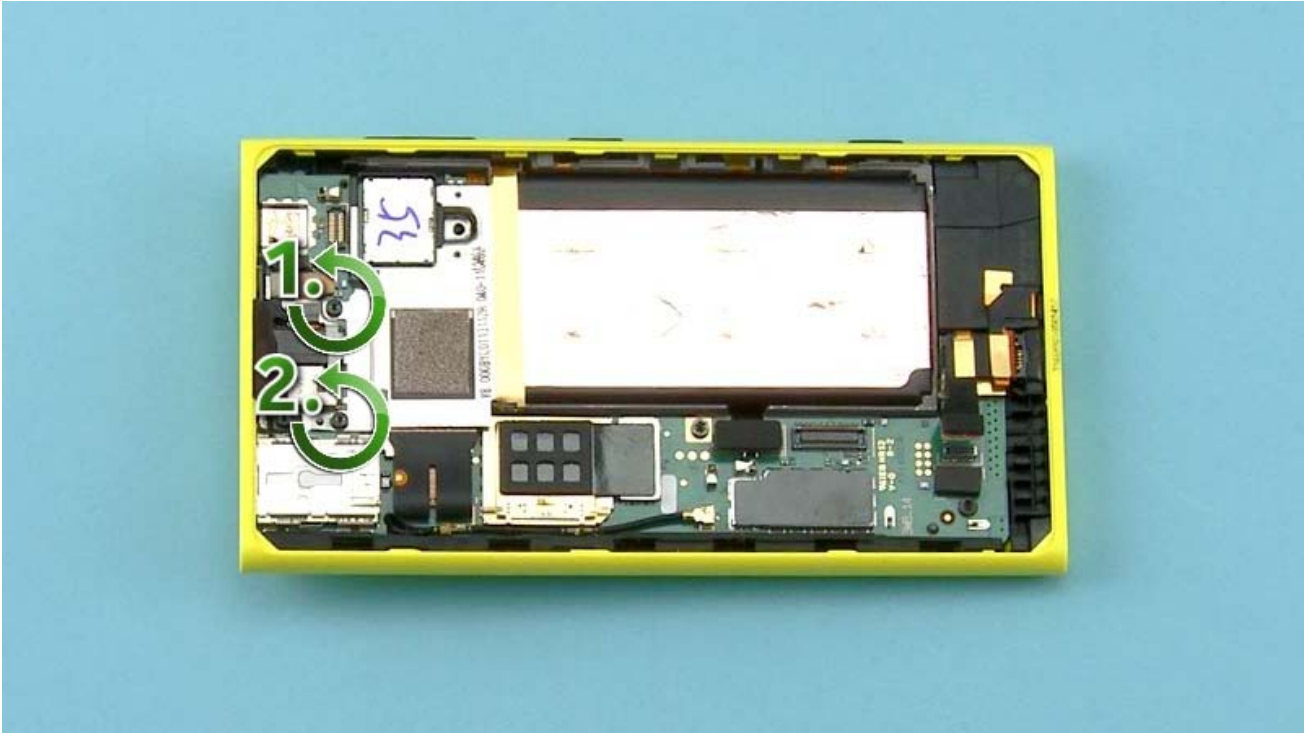

20) Unscrew the two TORX+ size 5 screws in the order shown.

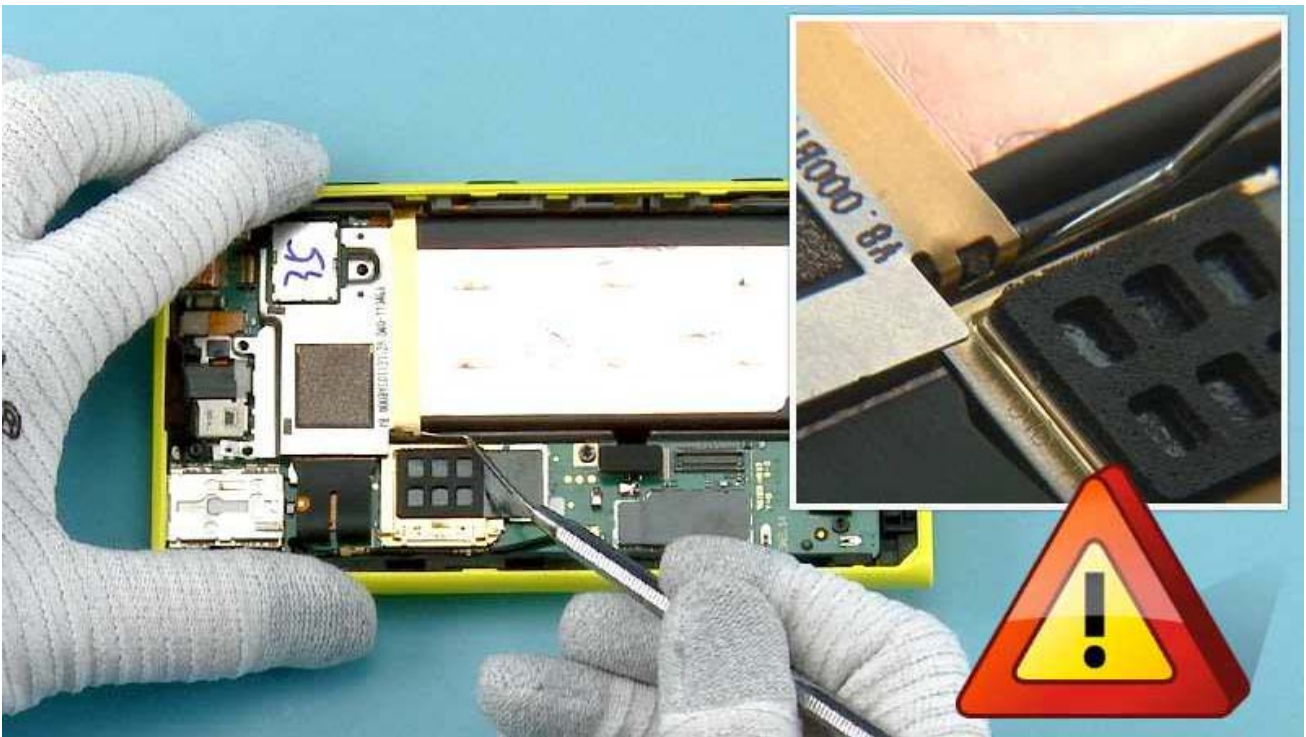

21) Use the dental tool to release the snaps holding the BATTERY HOLDER.

Be careful not to injure yourself with the sharp end of the dental tool.



22) Use tweezers to remove the BATTERY HOLDER.



23) Open the CAMERA CONNECTOR with the SS-93.

Be careful not to damage the connector or any nearby components.

NOTE: The surface on the back of the CAMERA is very thin ceramic. To avoid damaging it do not touch or push the back of the camera.



24) Use tweezers to lift the CAMERA.

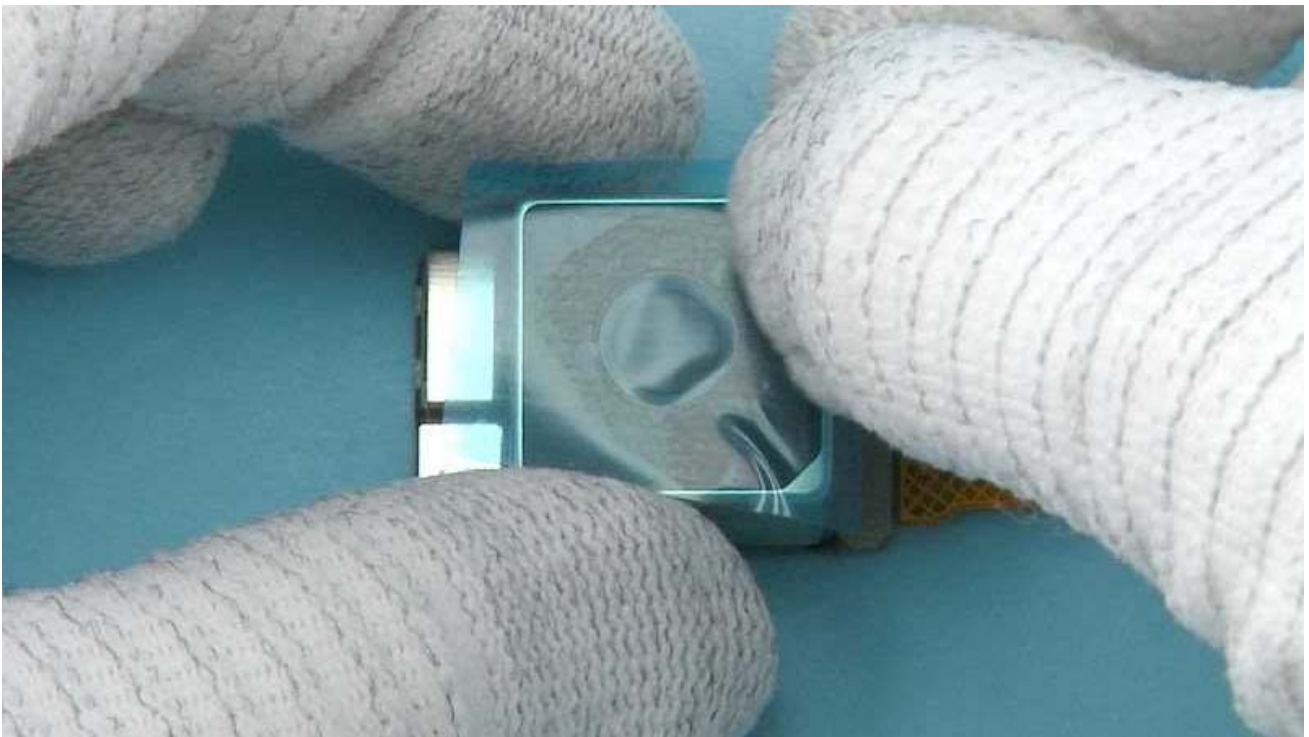

25) Protect the CAMERA LENS with protective film.

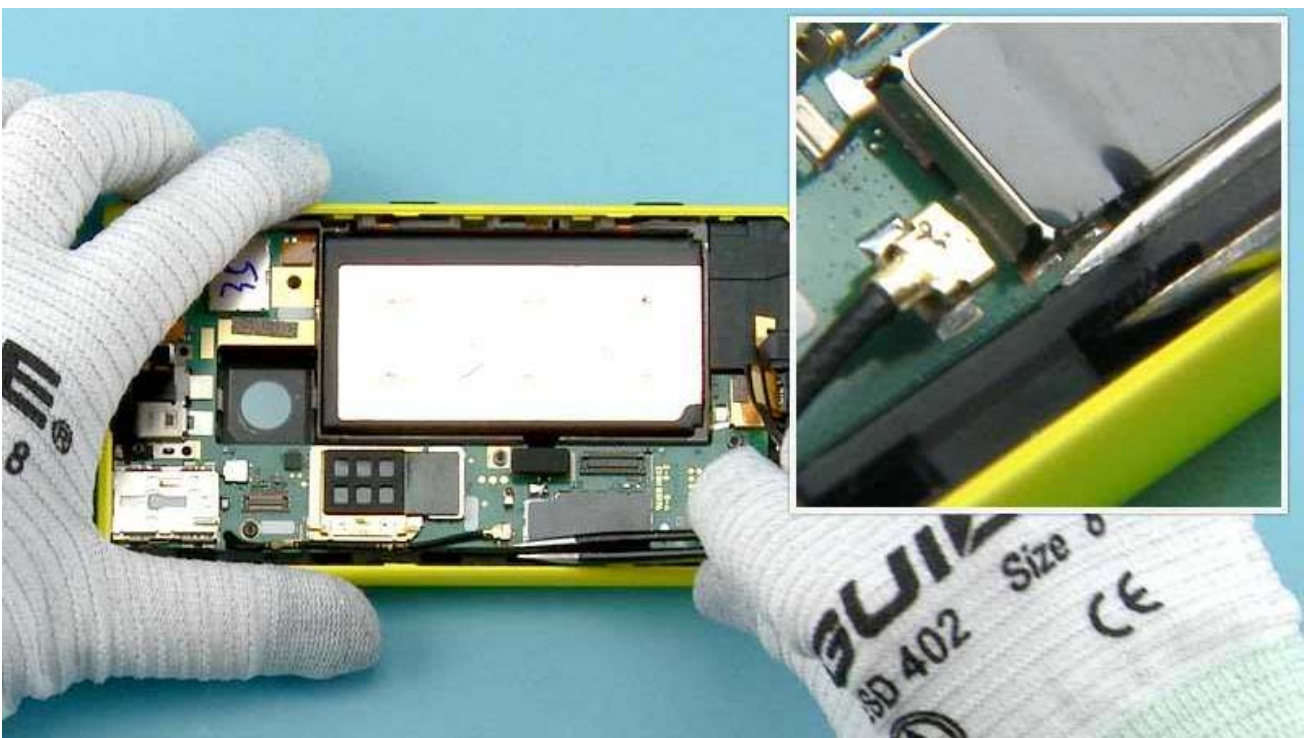

26) Use tweezers to detach the LOCKING RAIL.



27) Remove the LOCKING RAIL.



28) Use the SS-93 to open the SIDE KEY FLEX CONNECTOR.

Be careful not to damage the connector or any nearby components.



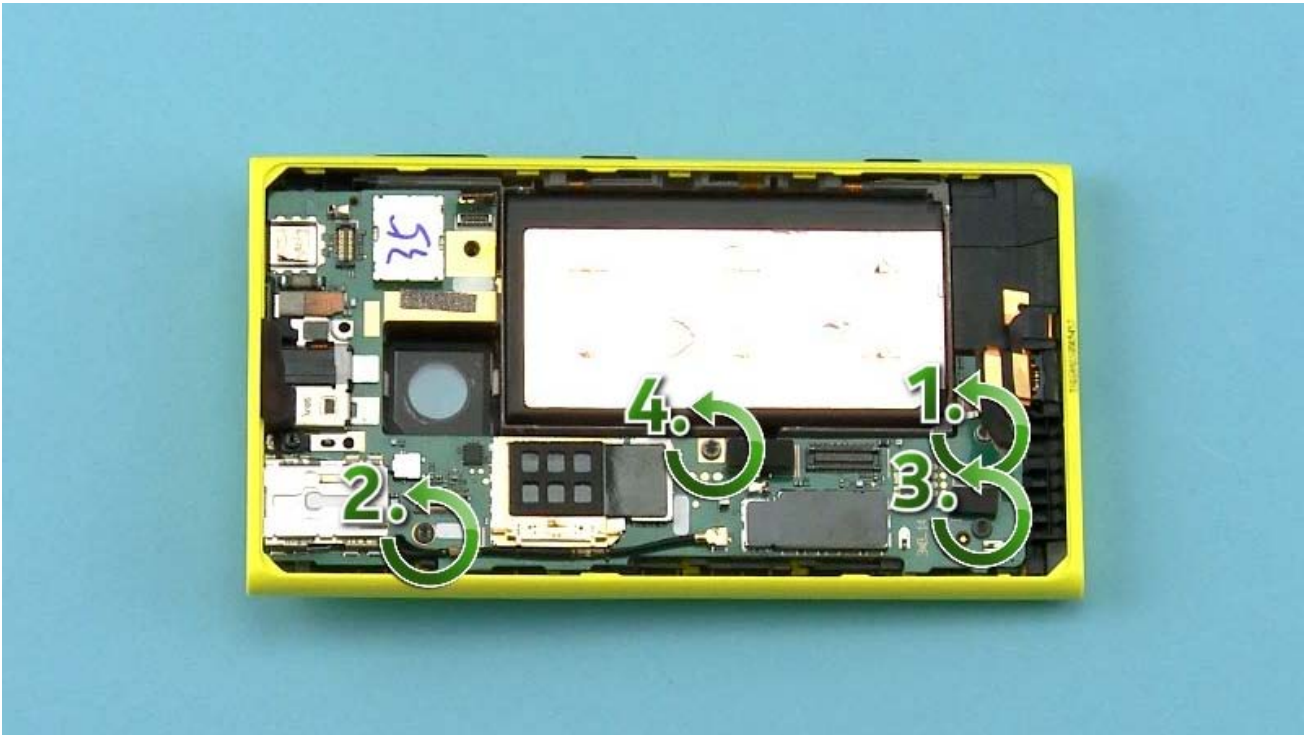

29) Unscrew the four TORX+ size 6 screws in the order shown.



30) Unscrew this TORX+ size 5 screw.

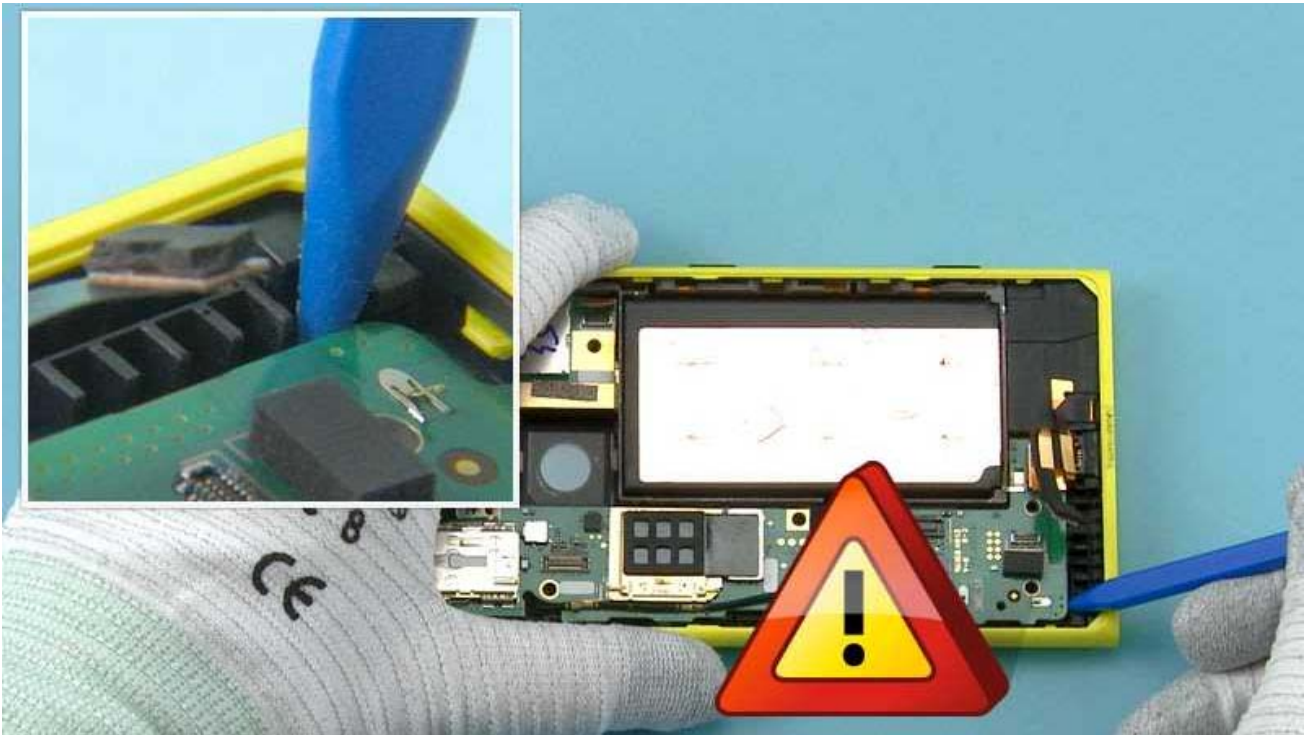

31) Insert the sharp end of the SS-93 into the shown place and lever the ENGINE BOARD carefully out.

Be careful not to damage any springs on the ENGINE BOARD, the USB FLEX or the SIDE KEY FLEX while lifting the ENGINE BOARD.



32) Lift up the bottom end of the ENGINE BOARD first.

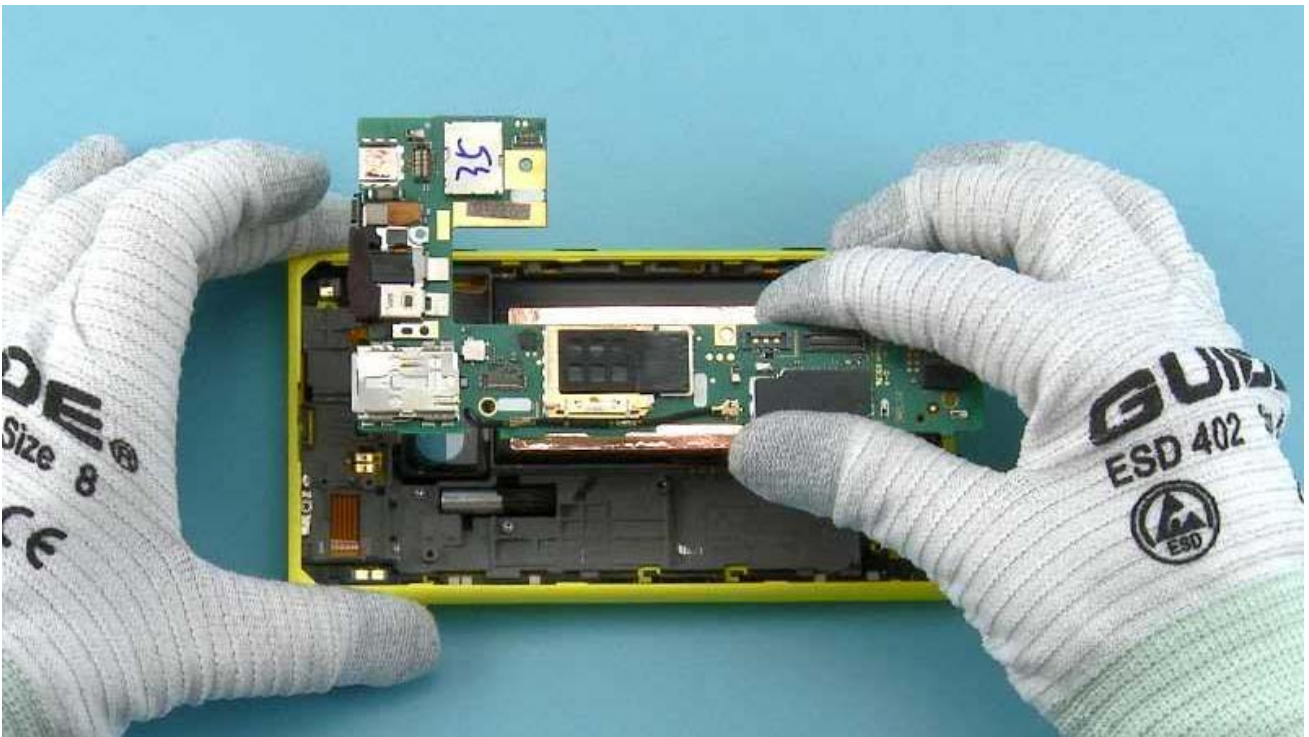

33) Remove the ENGINE BOARD.

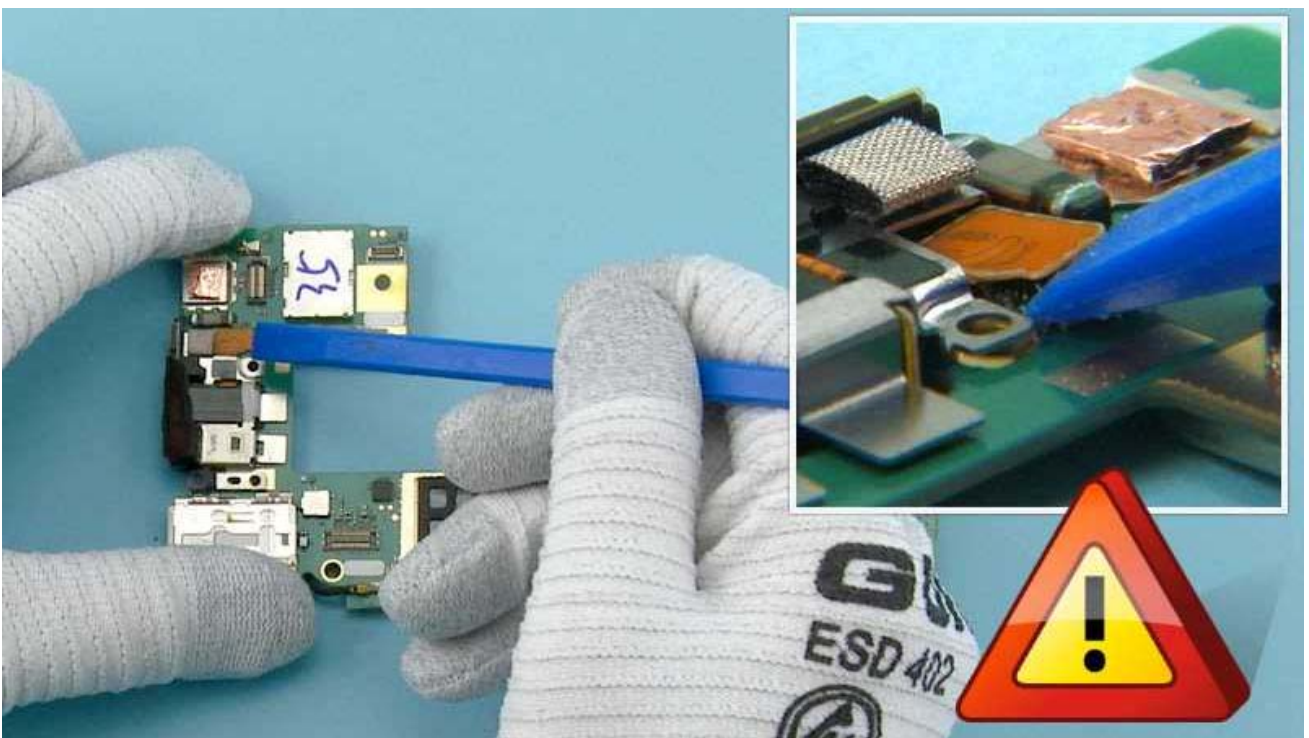

34) Use the SS-93 to open the AV ASSEMBLY CONNECTOR.

Be careful not to damage the connector or any nearby components.

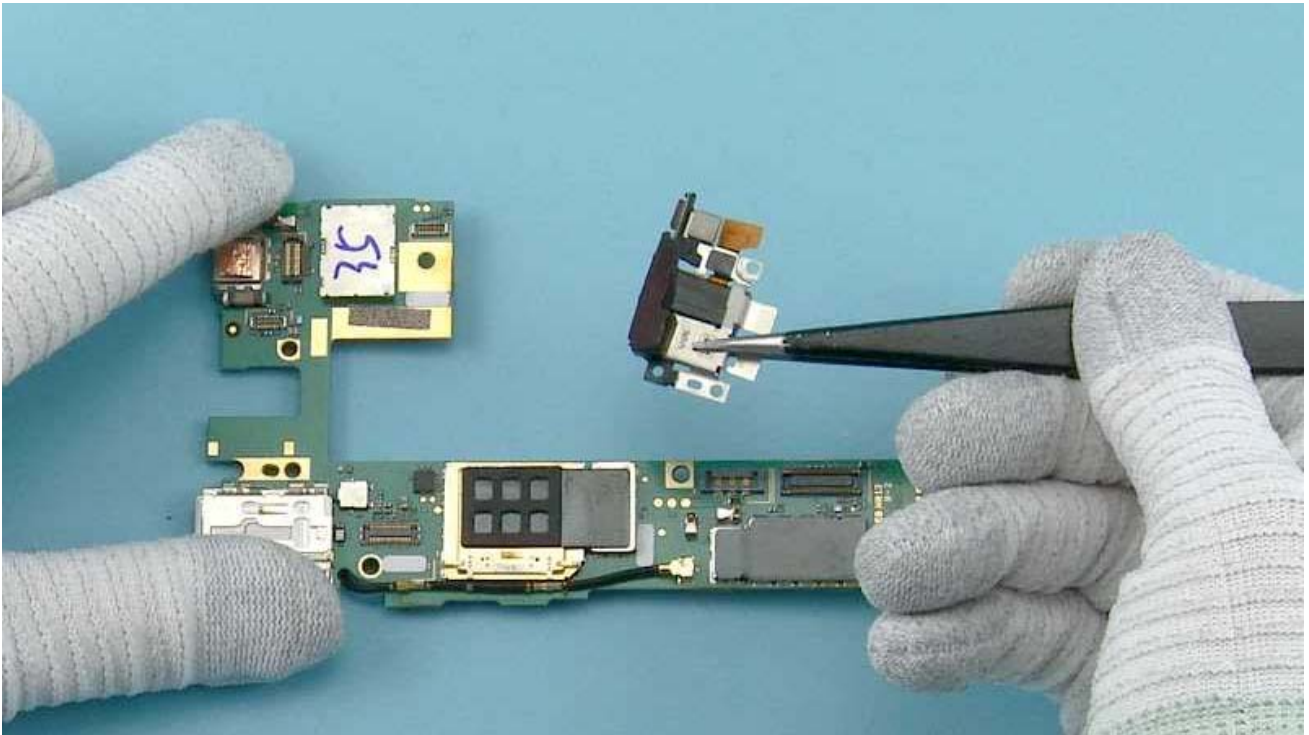

35) Use tweezers to remove the AV ASSEMBLY.



36) Detach the AV FRAME GROUNDING FOAM with tweezers. Do not use it again. Discard it.

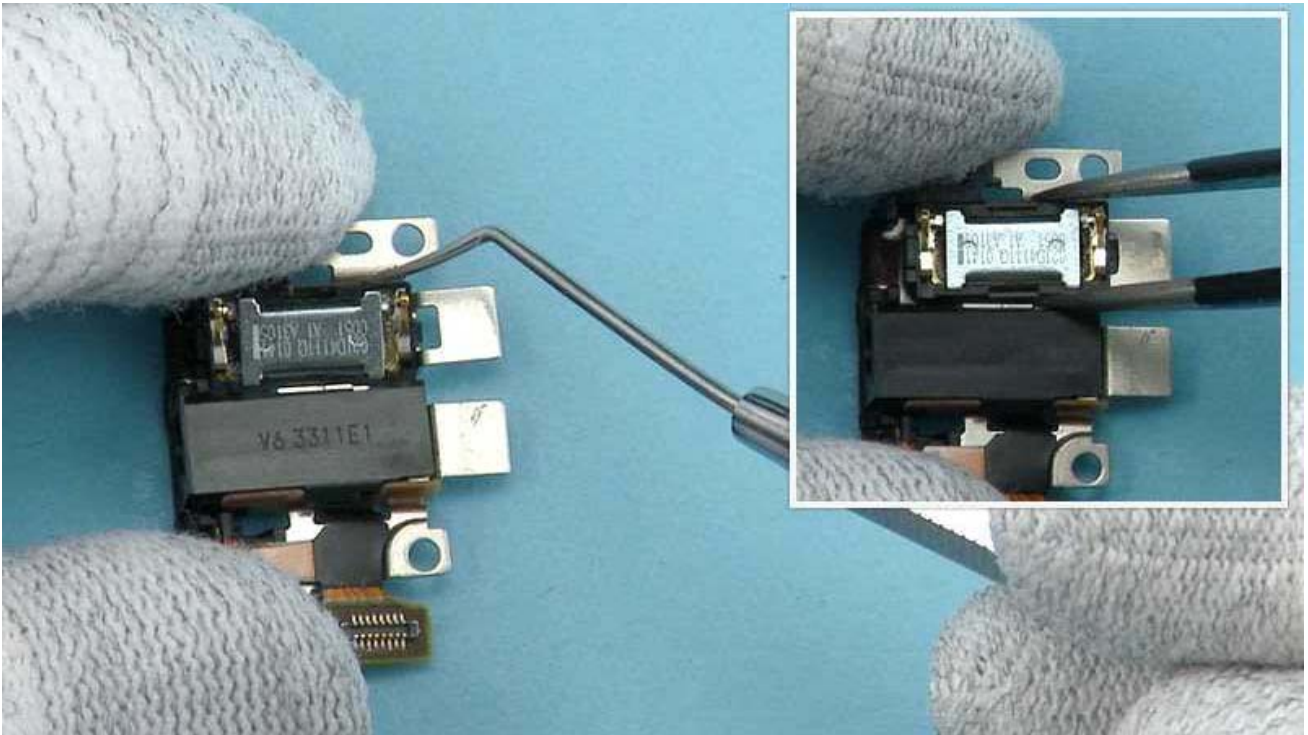

37) Release the EARPIECE with the dental tool. Remove the EARPIECE with tweezers.

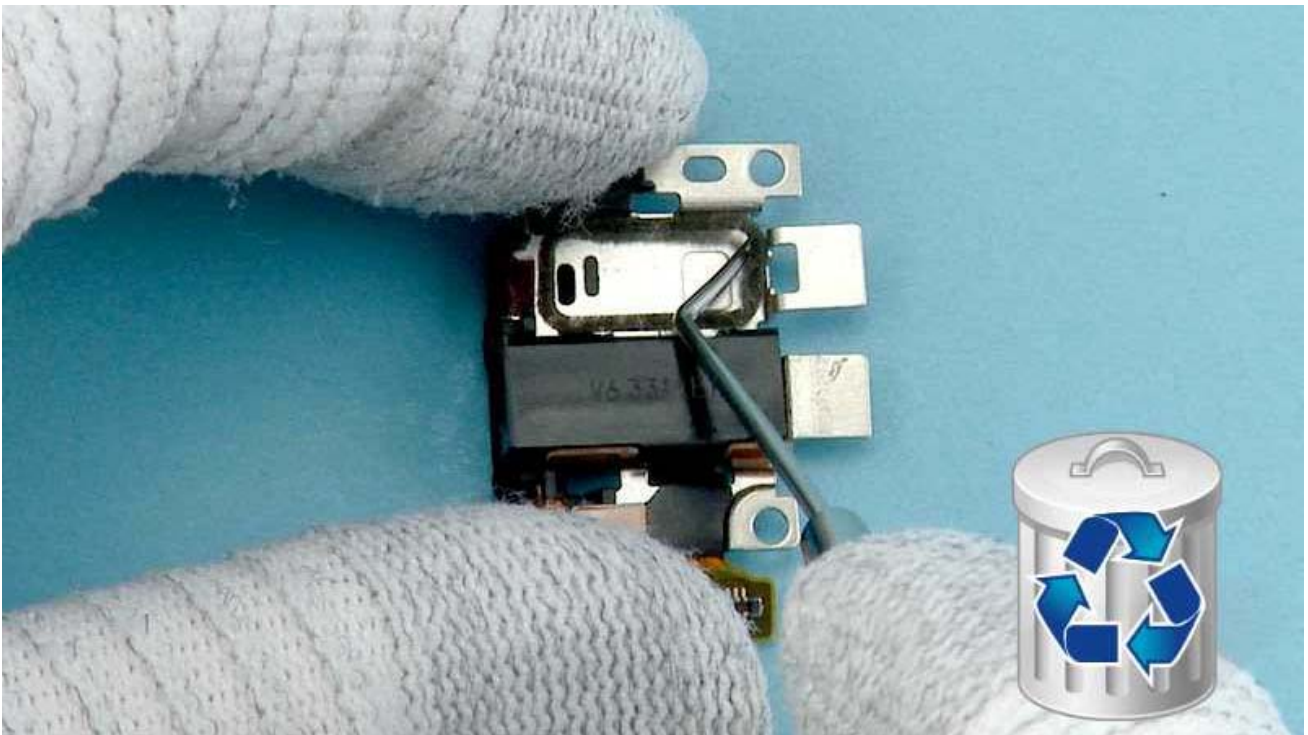

38) Detach the EARPIECE GASKET with the dental tool. Do not reuse it. Discard it.

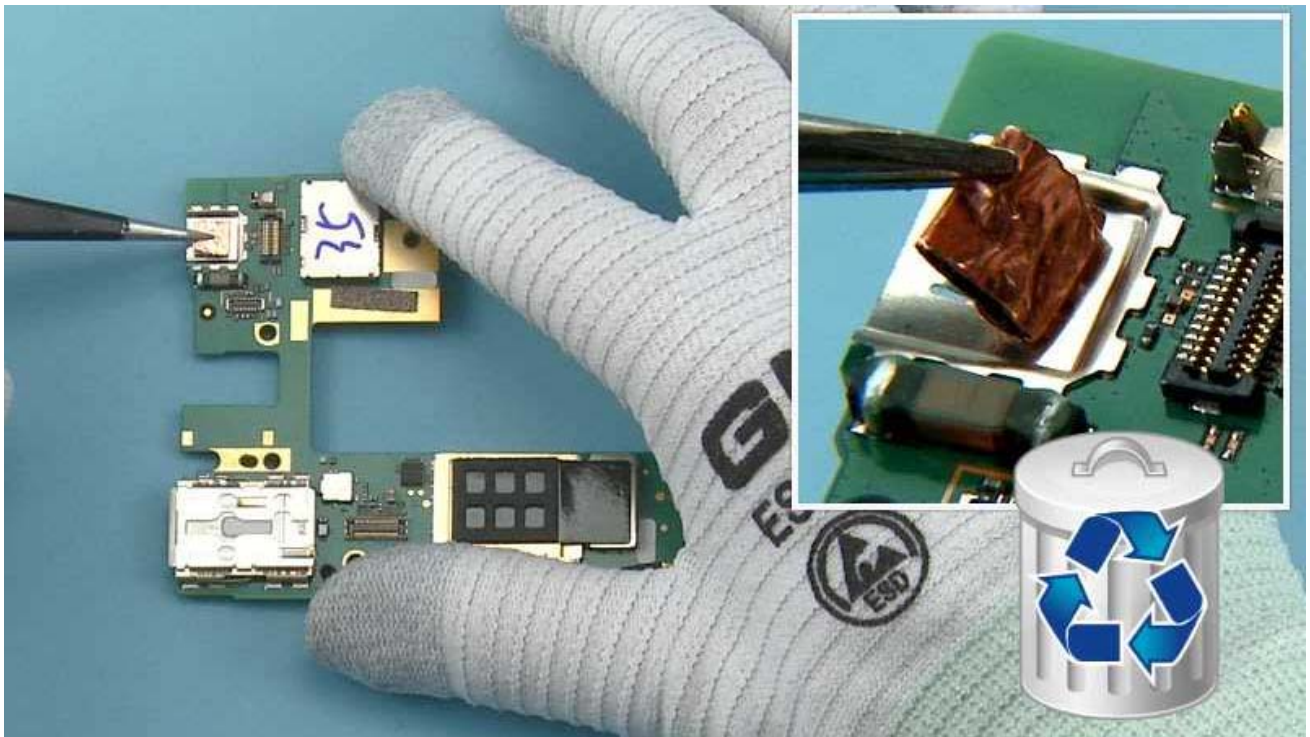

39) Remove the 2nd CAMERA GROUNDING PAD with tweezers. Do not use it again. Discard it.



40) Use the SS-93 to release and lift the BATTERY.



41) Remove the BATTERY.

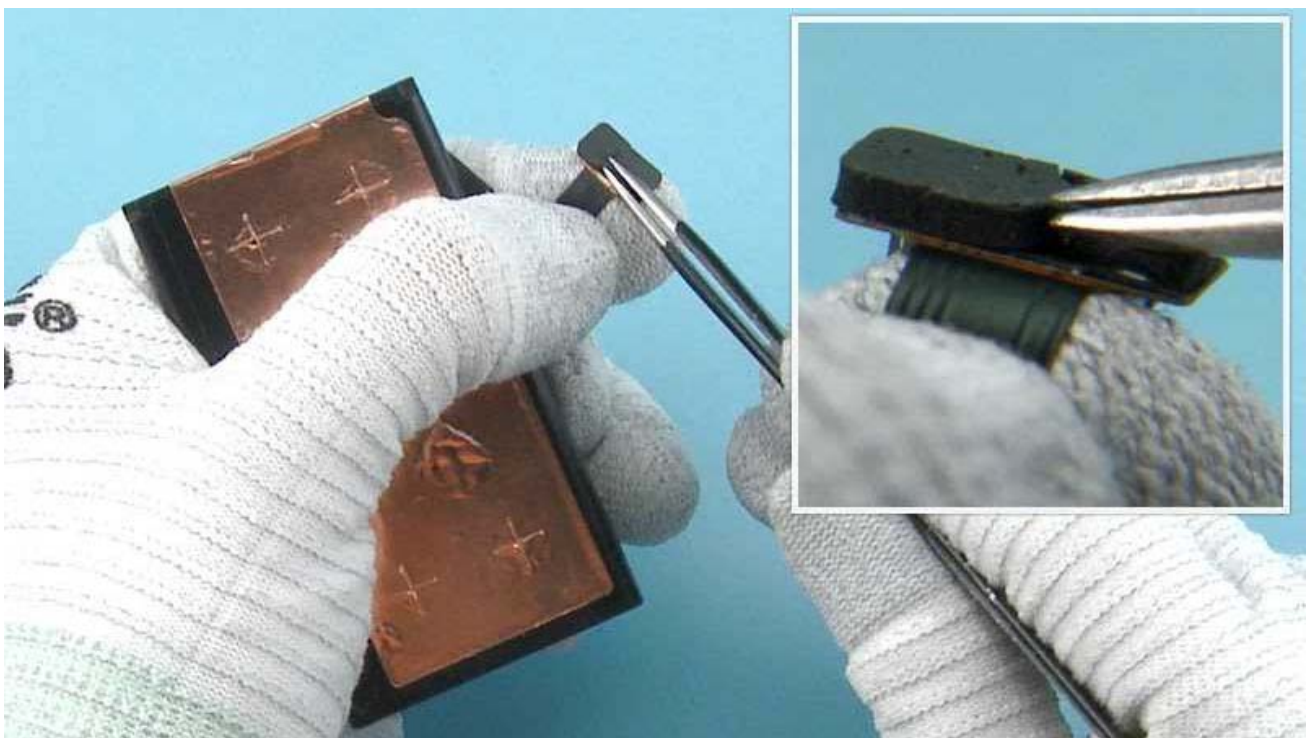

42) Detach the BATTERY GASKET with tweezers.

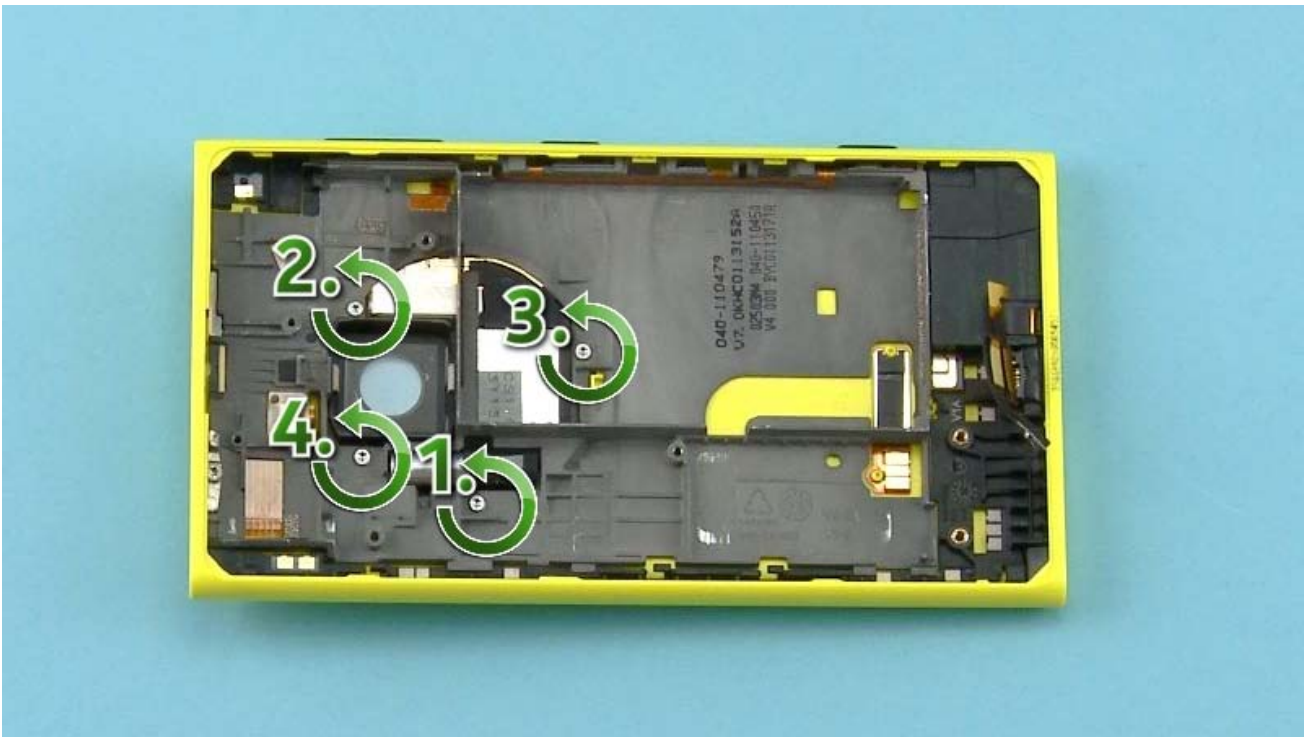

43) Unscrew the four TORX+ size 4 screws in the order shown.



44) Lift the BODY ASSEMBLY to separate the CAMERA DECO.



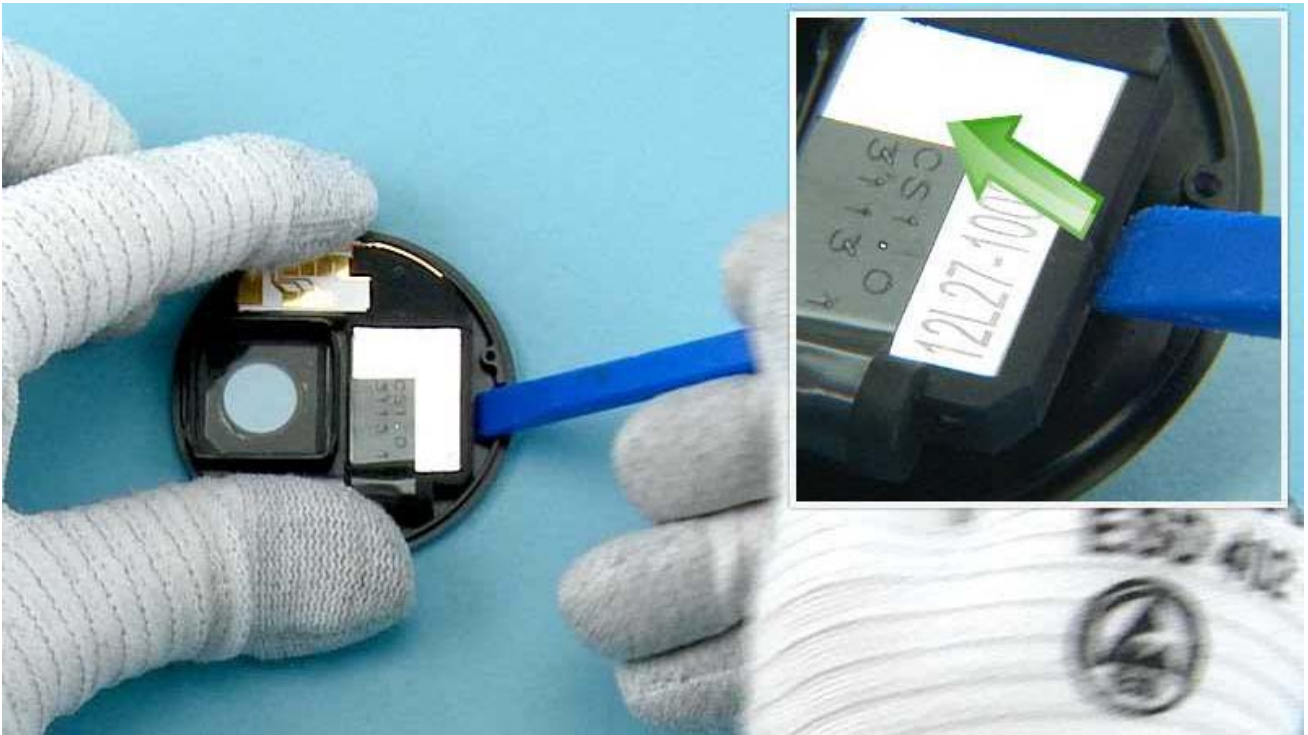

45) Use the SS-93 to lever out the XENON FLASH.

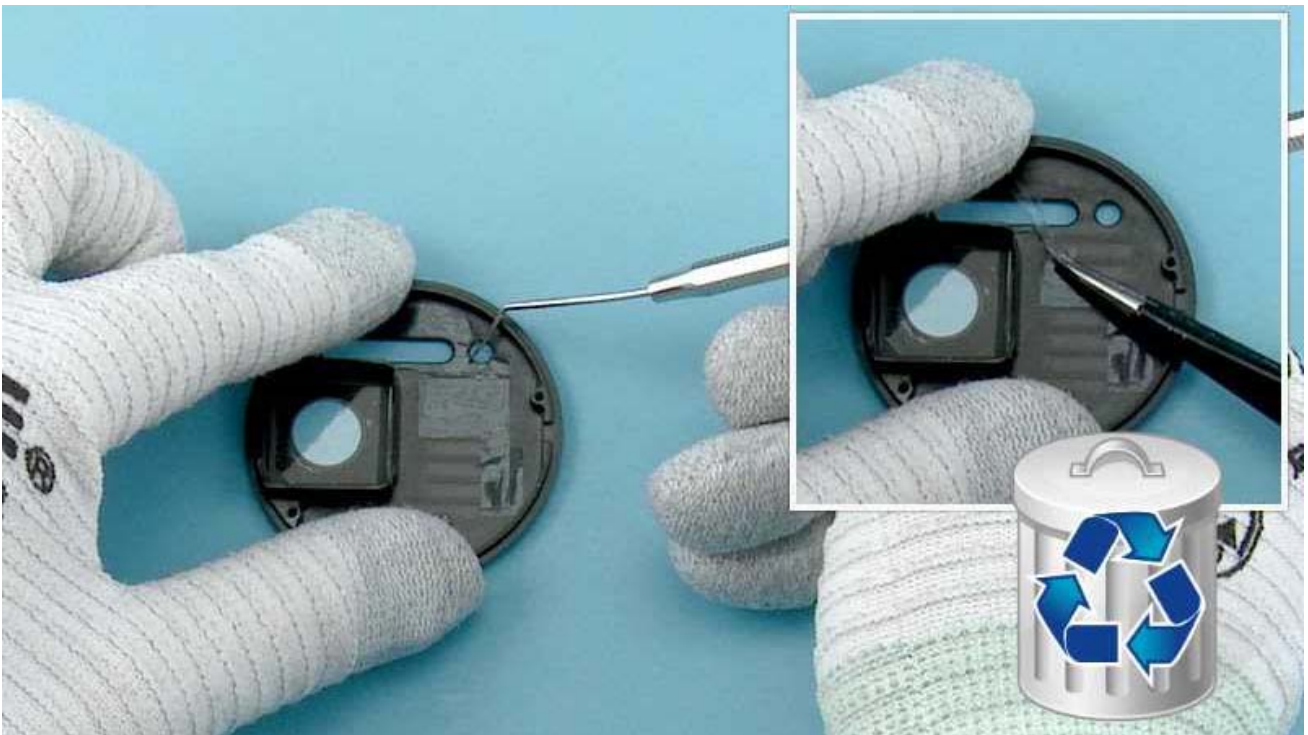

46) Release one corner of the FLASH ADHESIVE with the dental tool. Use tweezers to peel the adhesive off. The adhesive cannot be used again. Discard it.



47) Detach the USB GASKET with tweezers.



48) The Nokia Lumia 1020 disassembly procedure is complete.

-END OF DISASSEMBLY-



1) For assembling you need the Nokia Standard toolkit version 2.

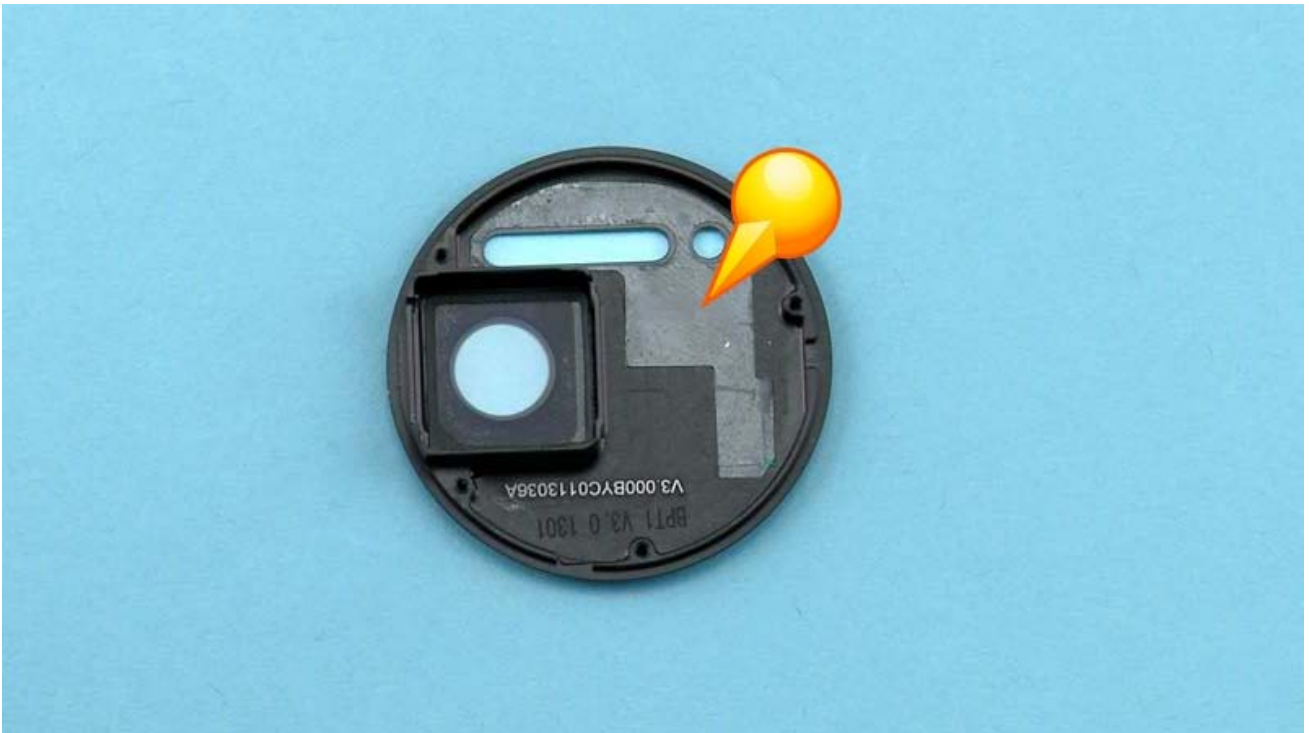

2) Place the FLASH ADHESIVE on the CAMERA DECO.



3) Put the XENON FLASH into its place and press it slightly to activate the adhesive.



4) Combine the CAMERA DECO and the BODY ASSEMBLY.

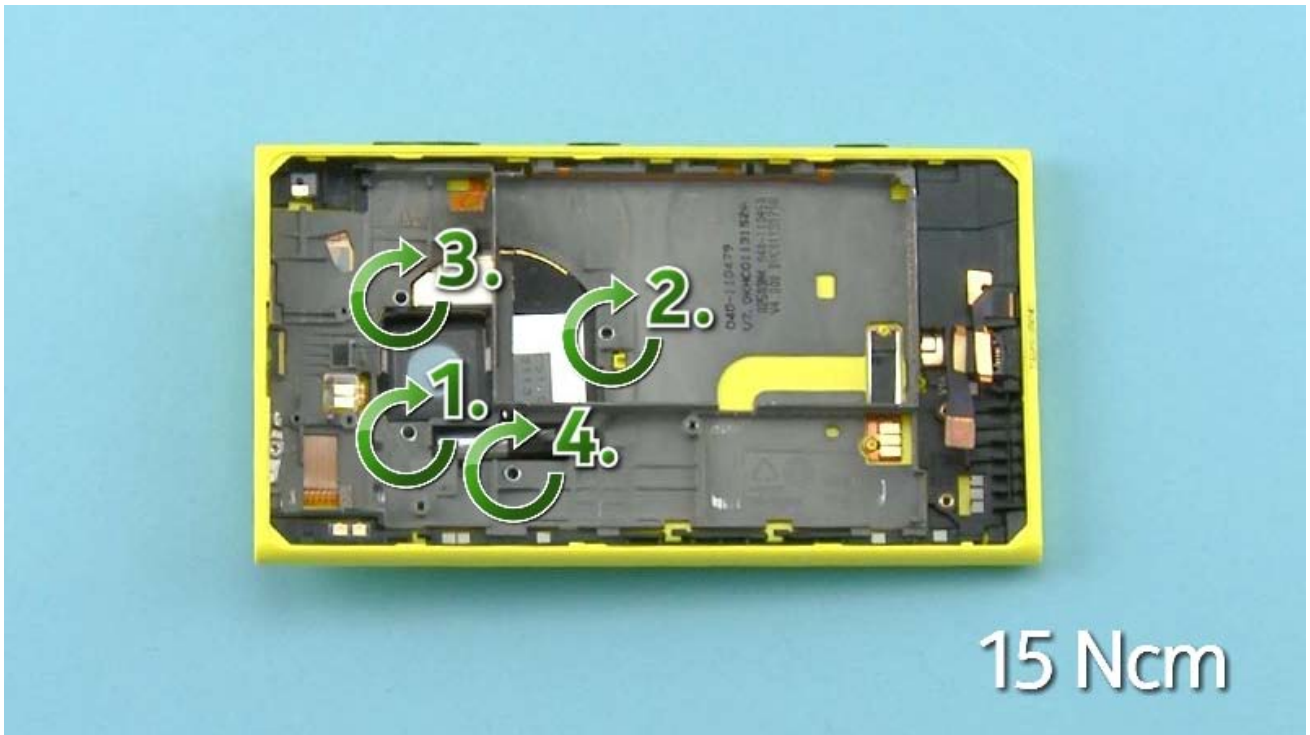

5) Fasten the four TORX+ size 4 screws in the order shown to the torque of 15 Ncm.

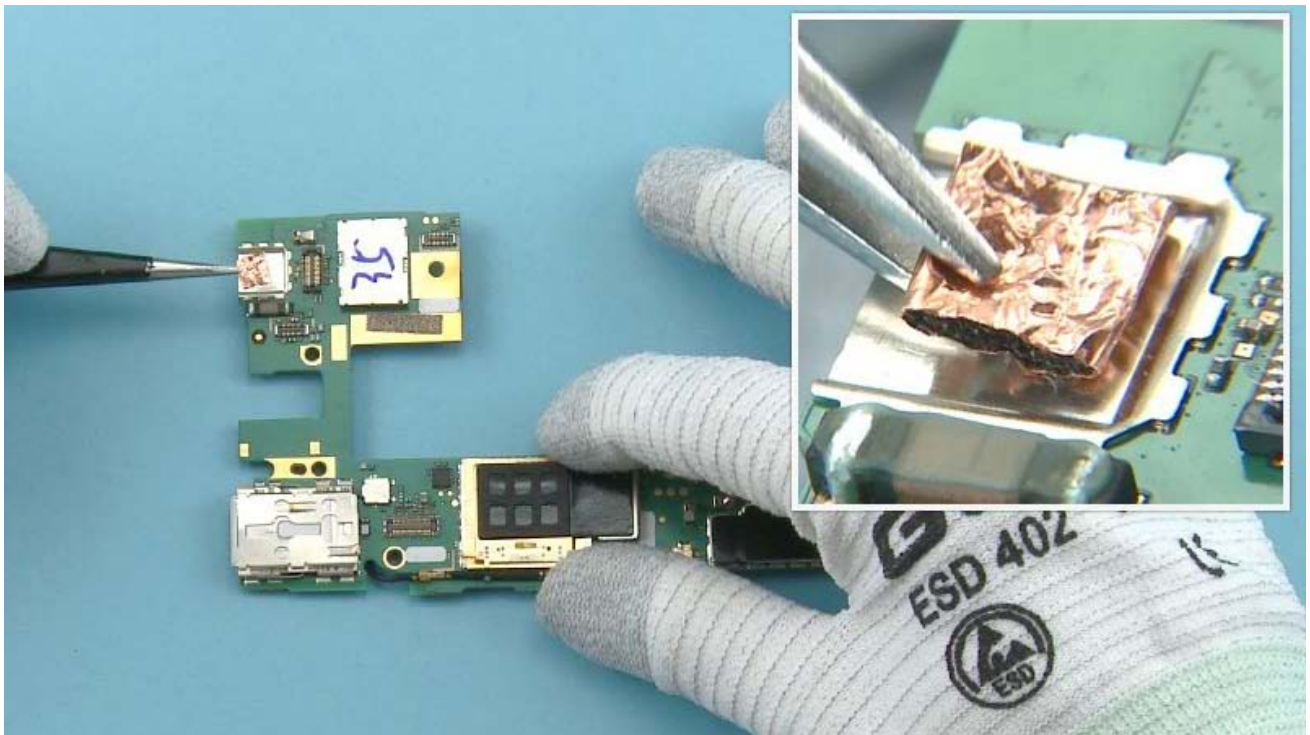

6) Use tweezers to attach the 2nd CAMERA GROUNDING PAD.

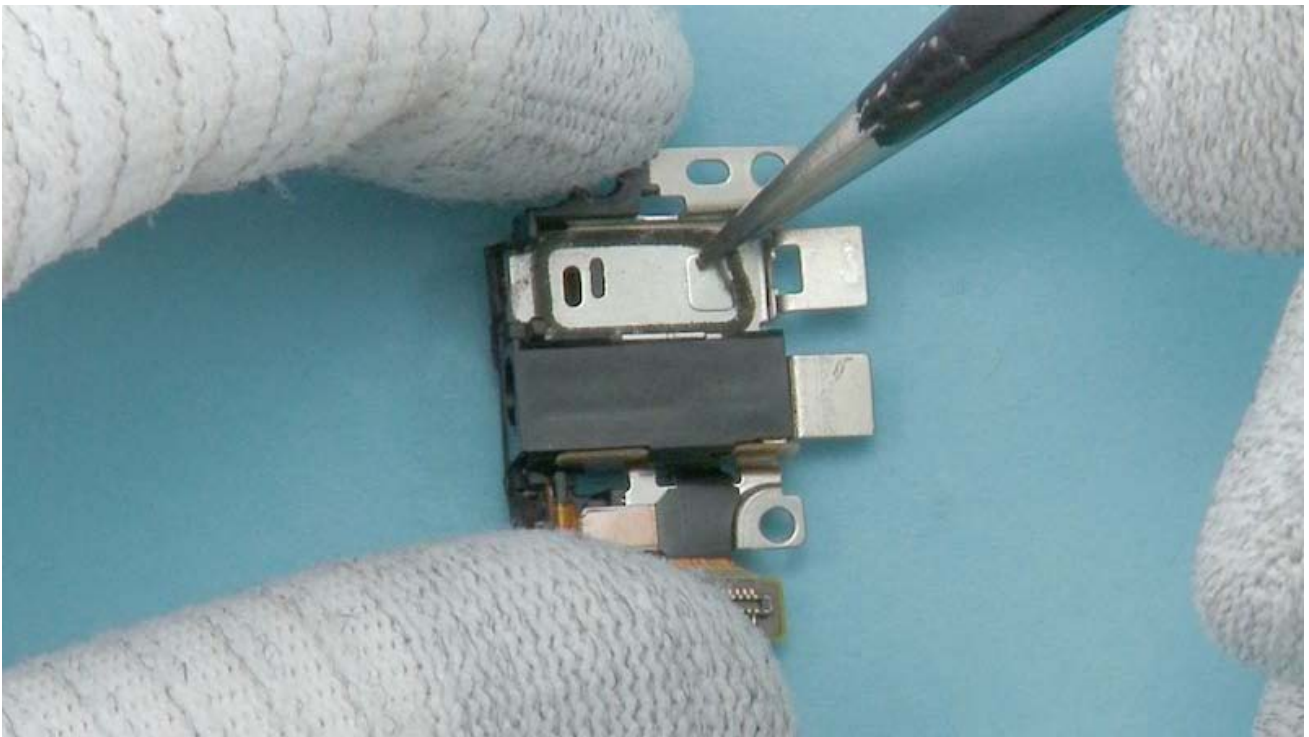

7) Place the EARPIECE HOLDER GASKET into its slot.

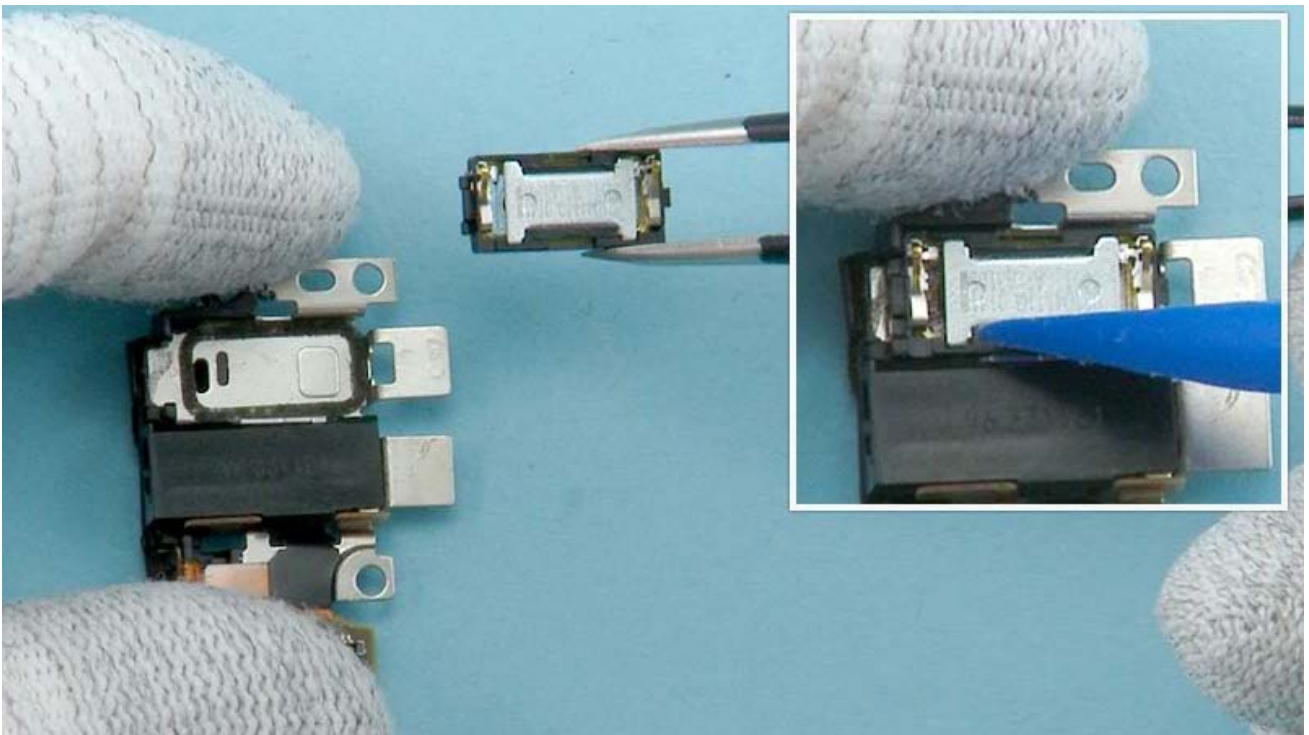

8) Use tweezers to place the EARPIECE into its slot. Press the EARPIECE gently from the black plastic parts to activate the adhesive.

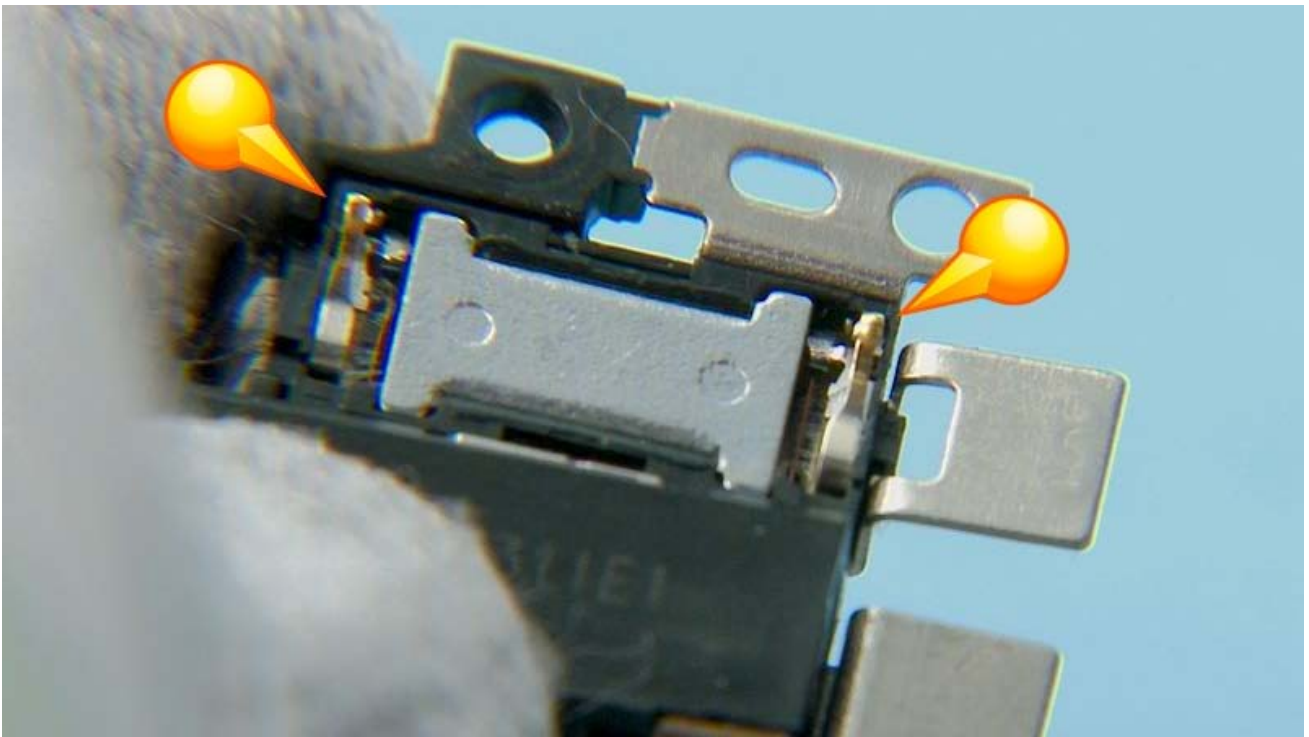

9) Make sure the EARPIECE is aligned correctly.

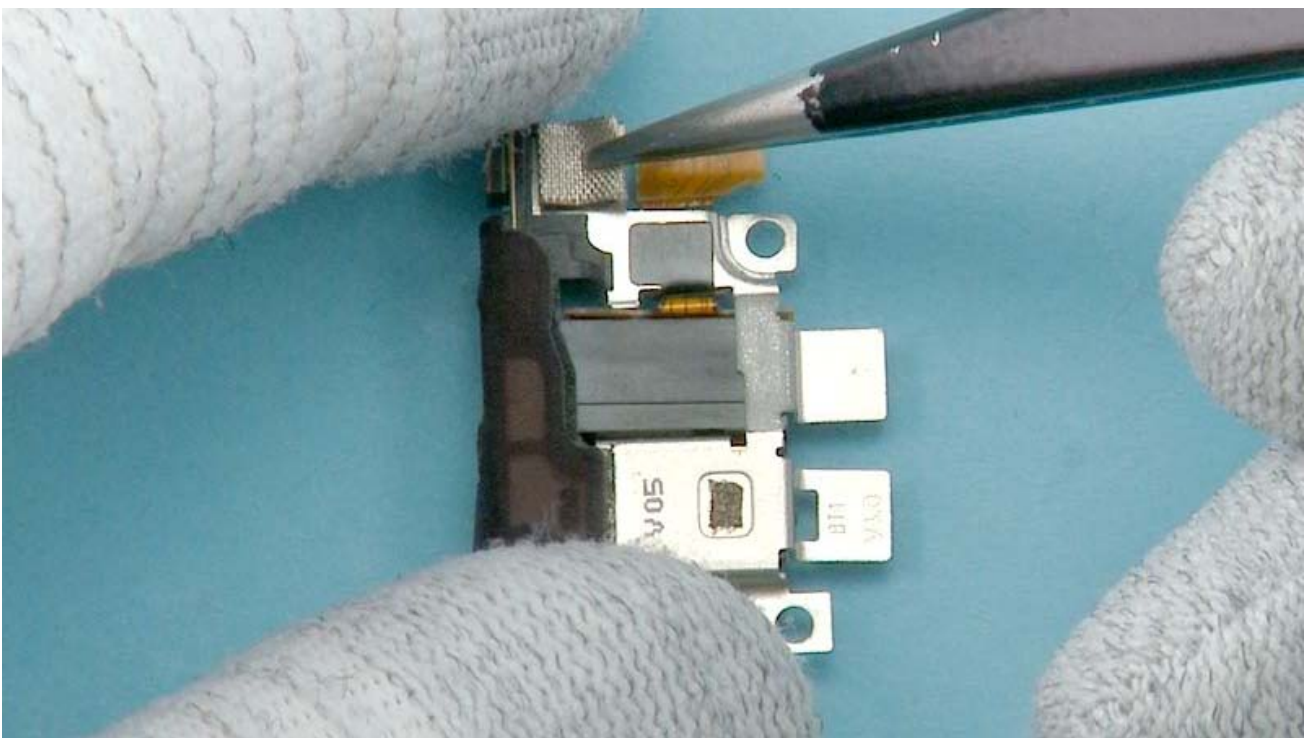

10) Attach the AV FRAME GROUNDING FOAM with tweezers.

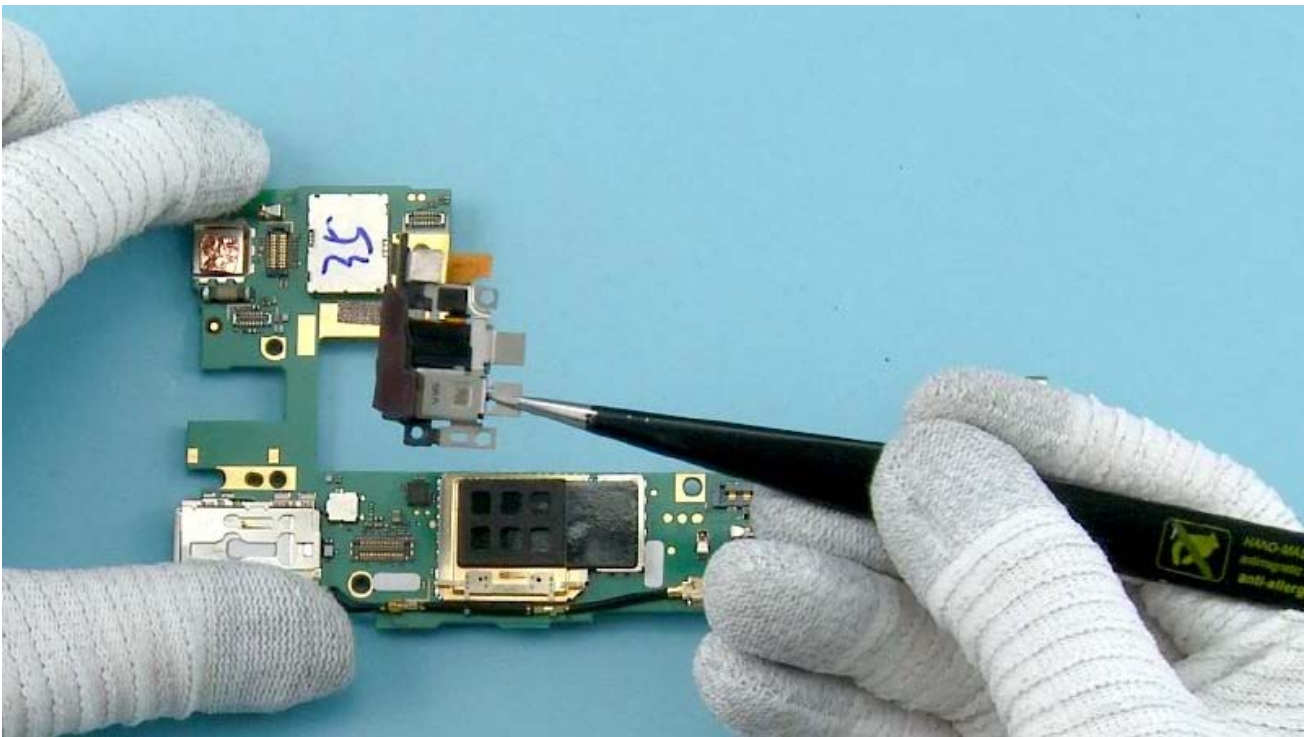

11) Use tweezers to align the AV ASSEMBLY on the ENGINE BOARD.



12) Use the SS-93 to connect the AV ASSEMBLY connector.

Be careful not to damage the connector or any nearby components.





13) Place the ENGINE BOARD to the BODY ASSEMBLY top end first.

While aligning the ENGINE BOARD be careful not to damage the SIDE KEY FLEX connector.

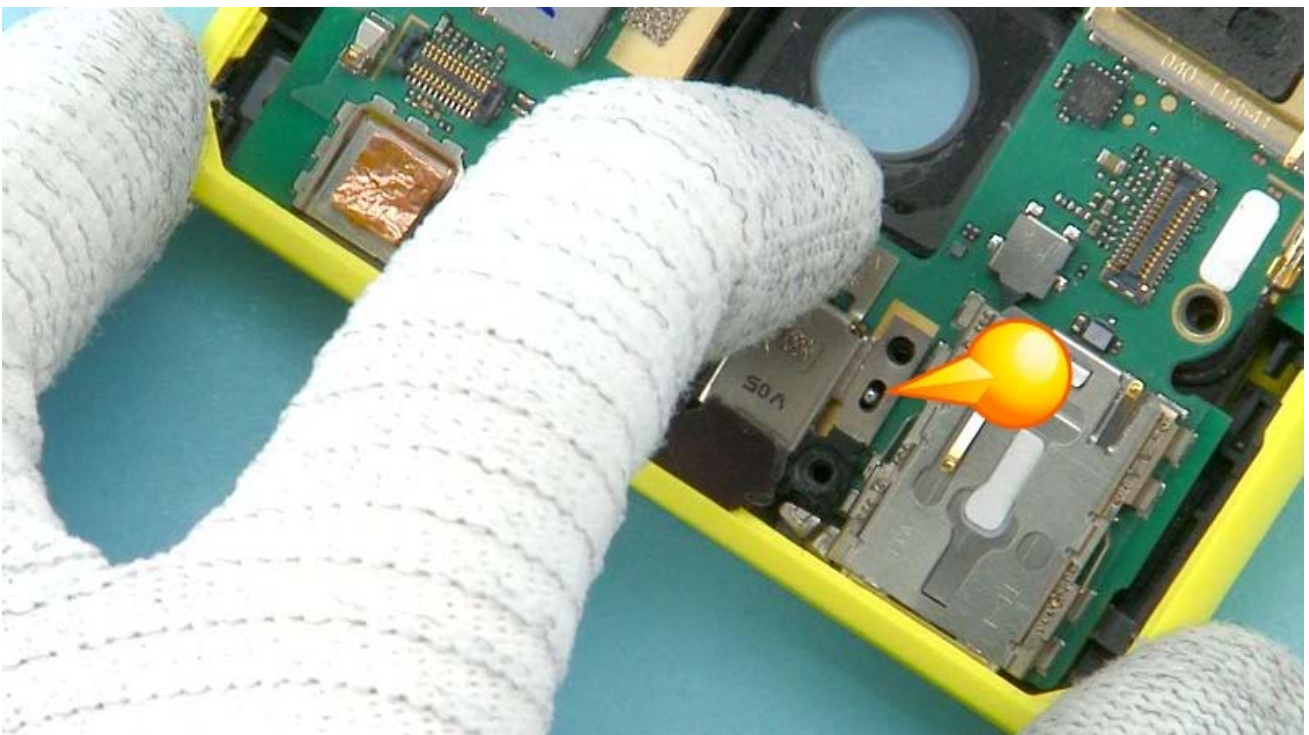

14) Check that the guiding pin goes through the ENGINE BOARD and the AV ASSEMBLY.



15) Put down the bottom end of the ENGINE BOARD.

While aligning the bottom end of the ENGINE BOARD be careful not to damage the USB FLEX connector.



16) Check that the guiding pin goes through engine board and the spring is against the chassis wall.

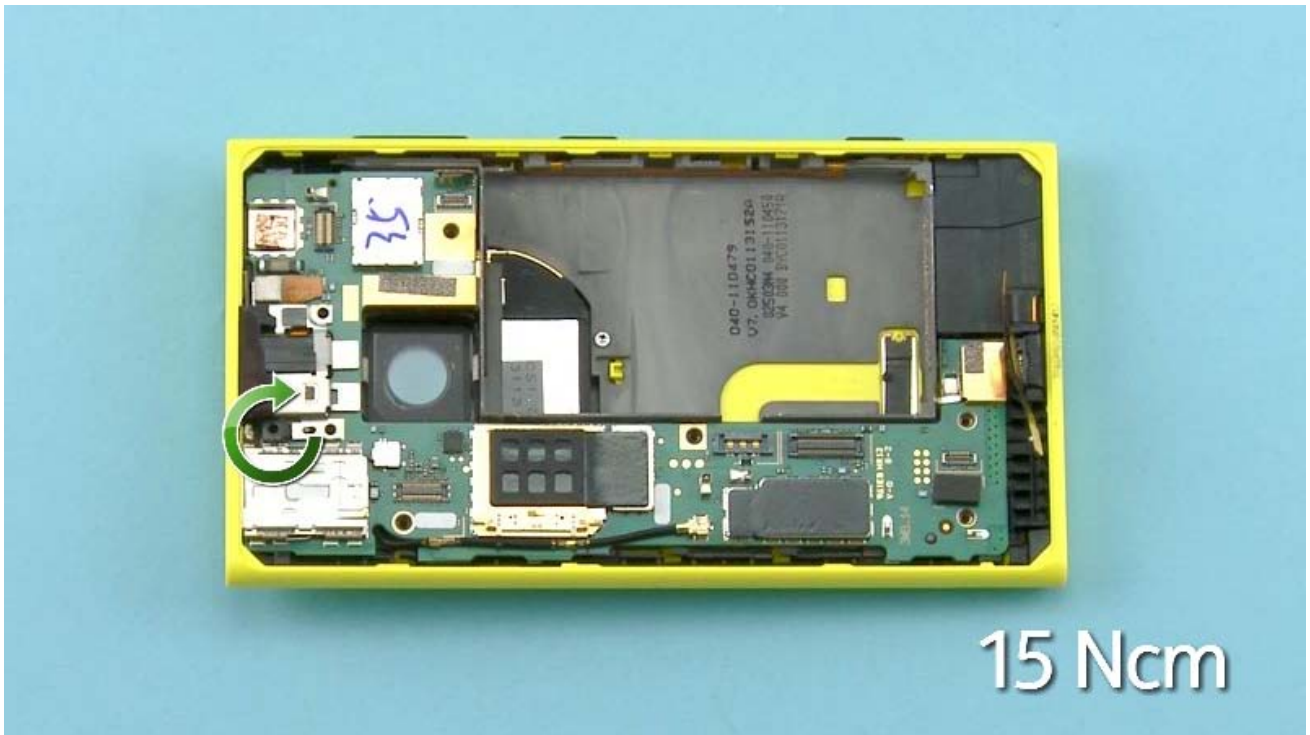

17) Fasten this TORX+ size 5 screw to the torque of 15 Ncm.

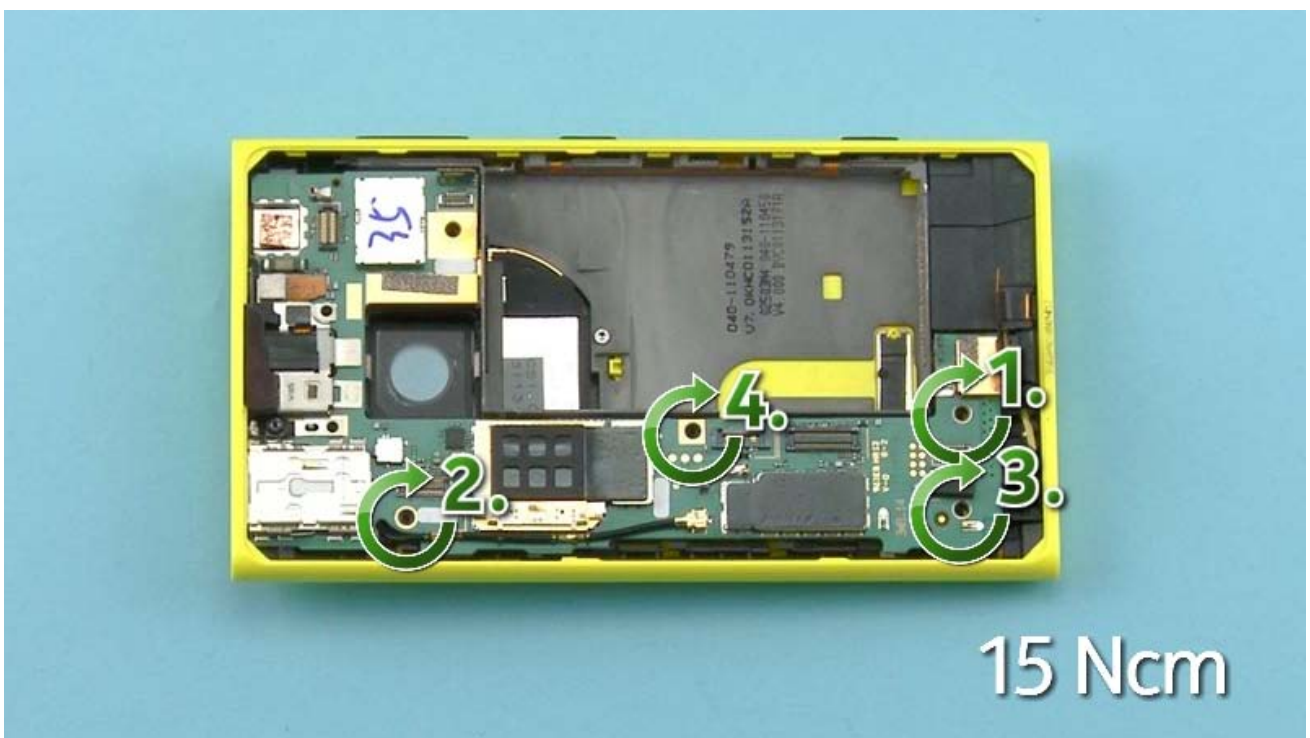

18) Fasten the four TORX+ size 6 screws in the order shown to the torque of 15 Ncm.



19) Use the SS-93 to connect the SIDE KEY FLEX connector.

Be careful not to damage the connector or any nearby components.



20) Use the SS-93 to connect the USB connector.

Be careful not to damage the connector or any nearby components.

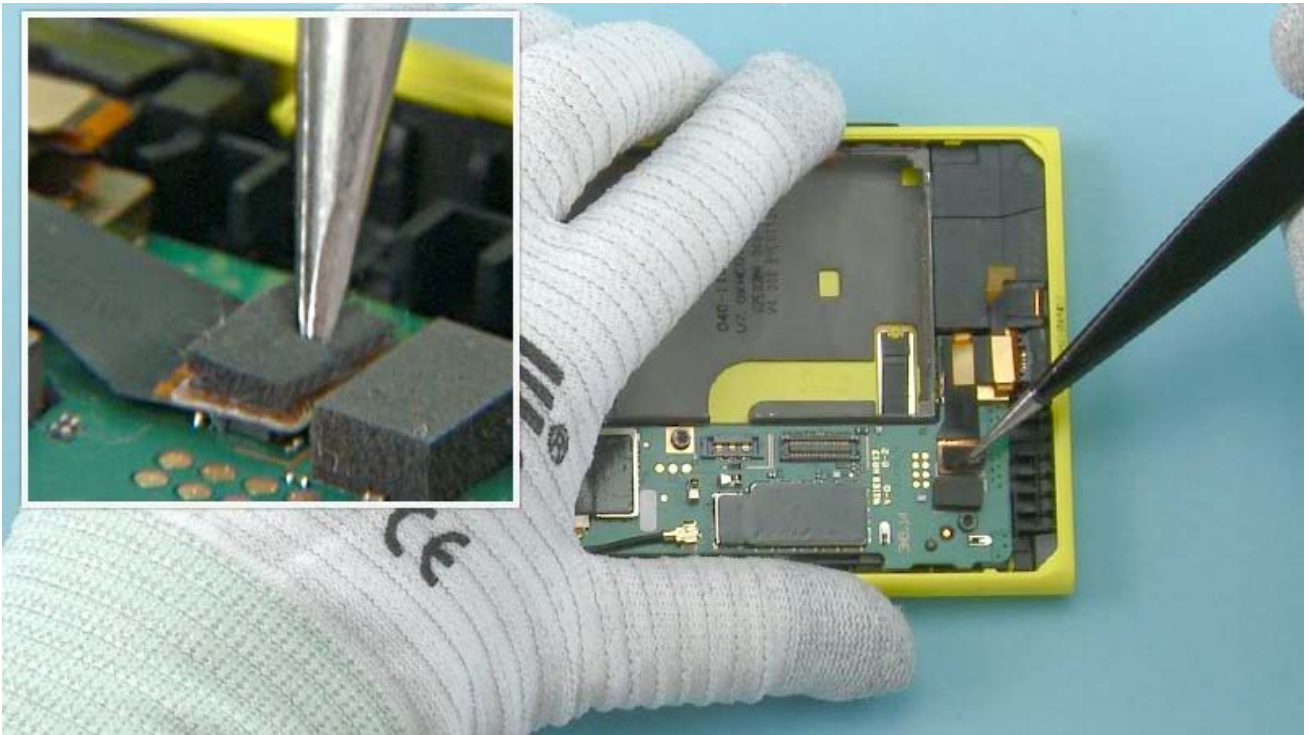

21) Attach the USB GASKET with tweezers.



22) Use tweezers to place the LOCKING RAIL ASSEMBLY top end first.

Make sure that the ANTENNA COAX CABLE is not under the LOCKING RAIL ASSEMBLY.

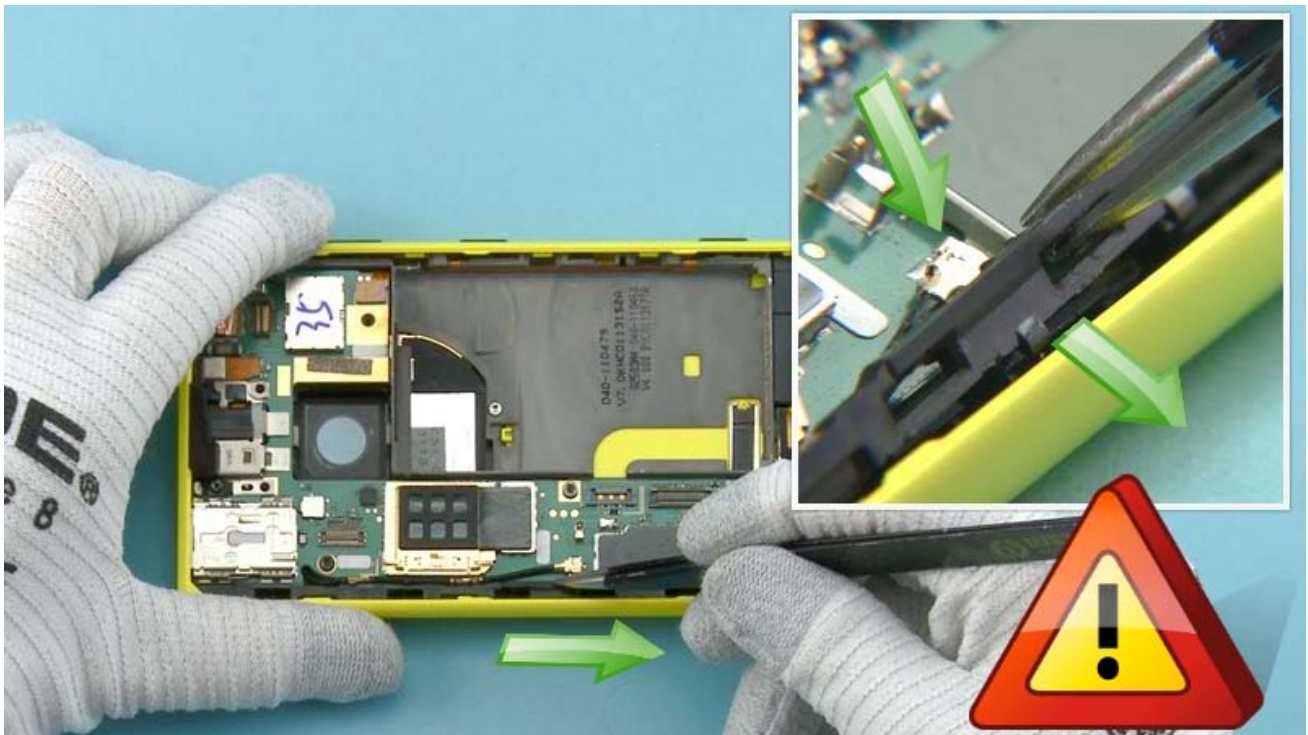

23) Put down the LOCKING RAIL ASSEMBLY and turn it into its place. Then slide the LOCKING RAIL ASSEMBLY towards the bottom end of the device.

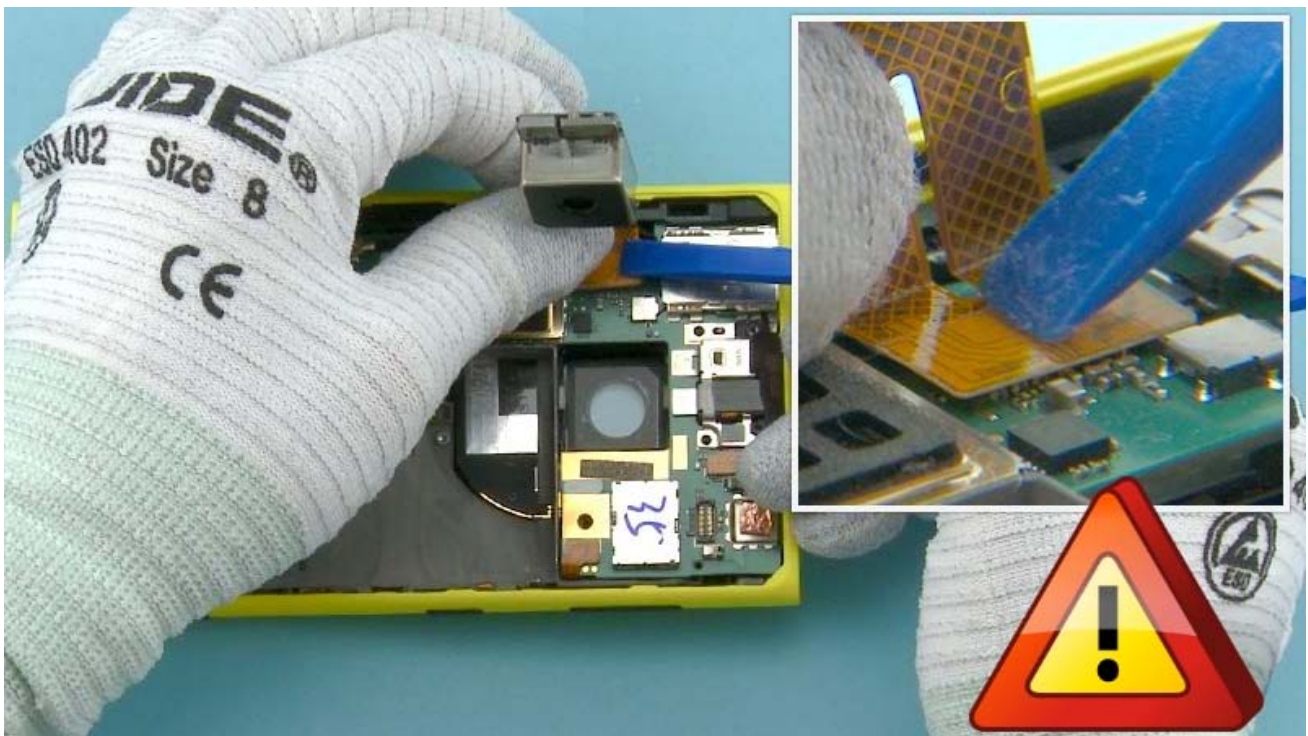

24) Connect the CAMERA connector with the SS-93.

Be careful not to damage the connector or any nearby components.

NOTE: The surface on the back of the CAMERA is very thin ceramic. To avoid damaging it do not touch or push the back of the camera.

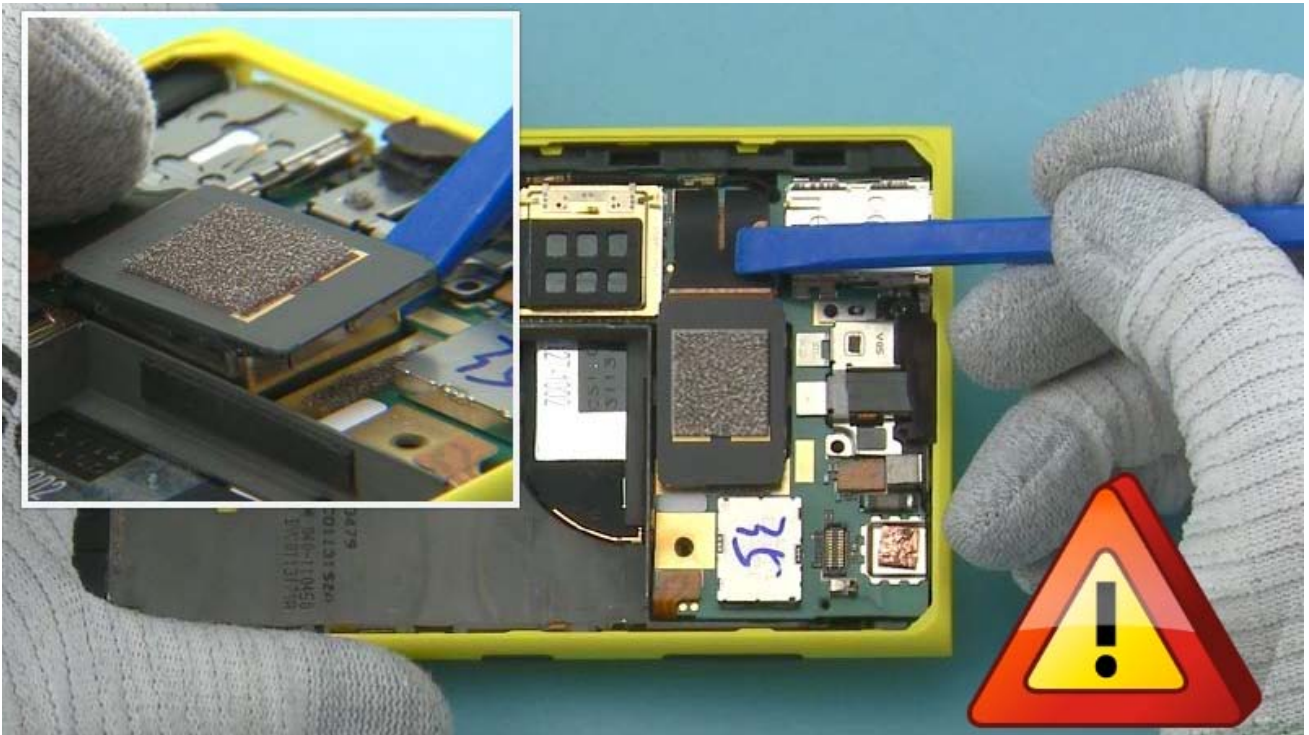

25) Place the CAMERA carefully into its cavity.

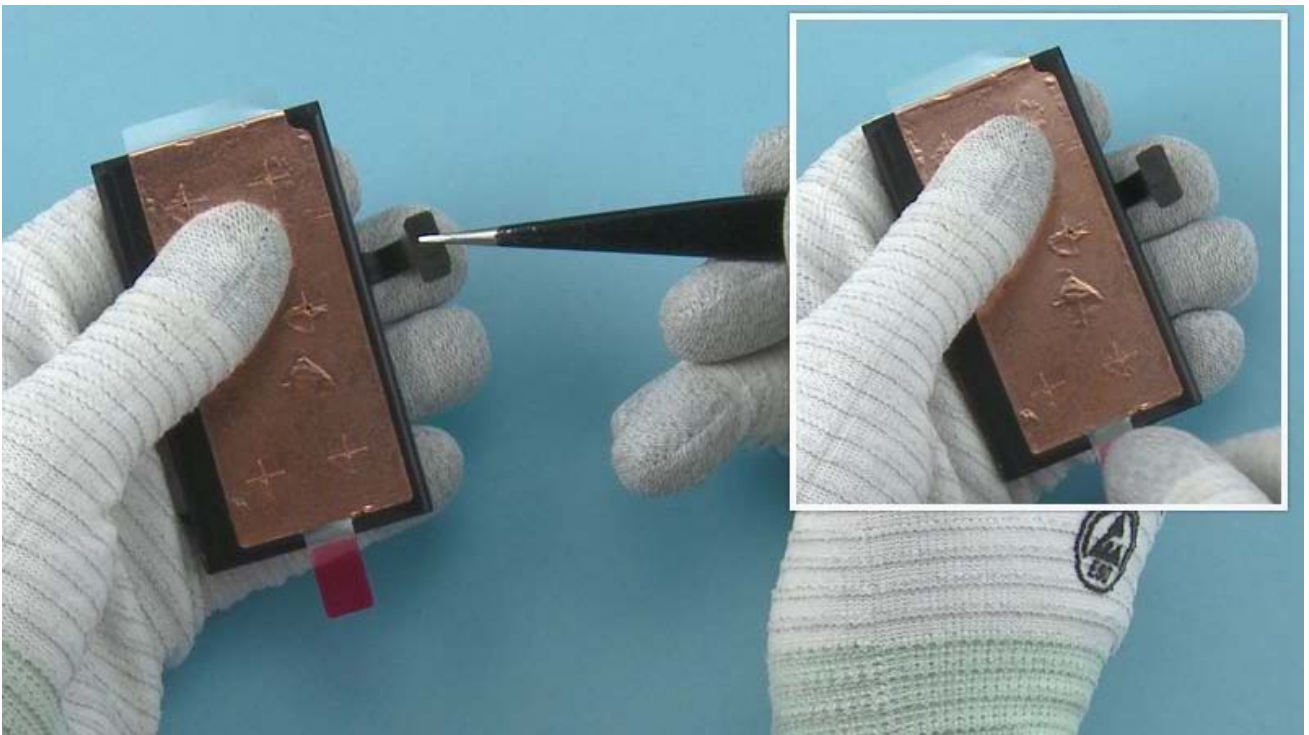

26) Attach the BATTERY GASKET with tweezers and remove the protective film from the BATTERY.



27) Place the BATTERY bottom end first.

NOTE: Do not connect the BATTERY CONNECTOR.



28) Place the BATTERY HOLDER with tweezers



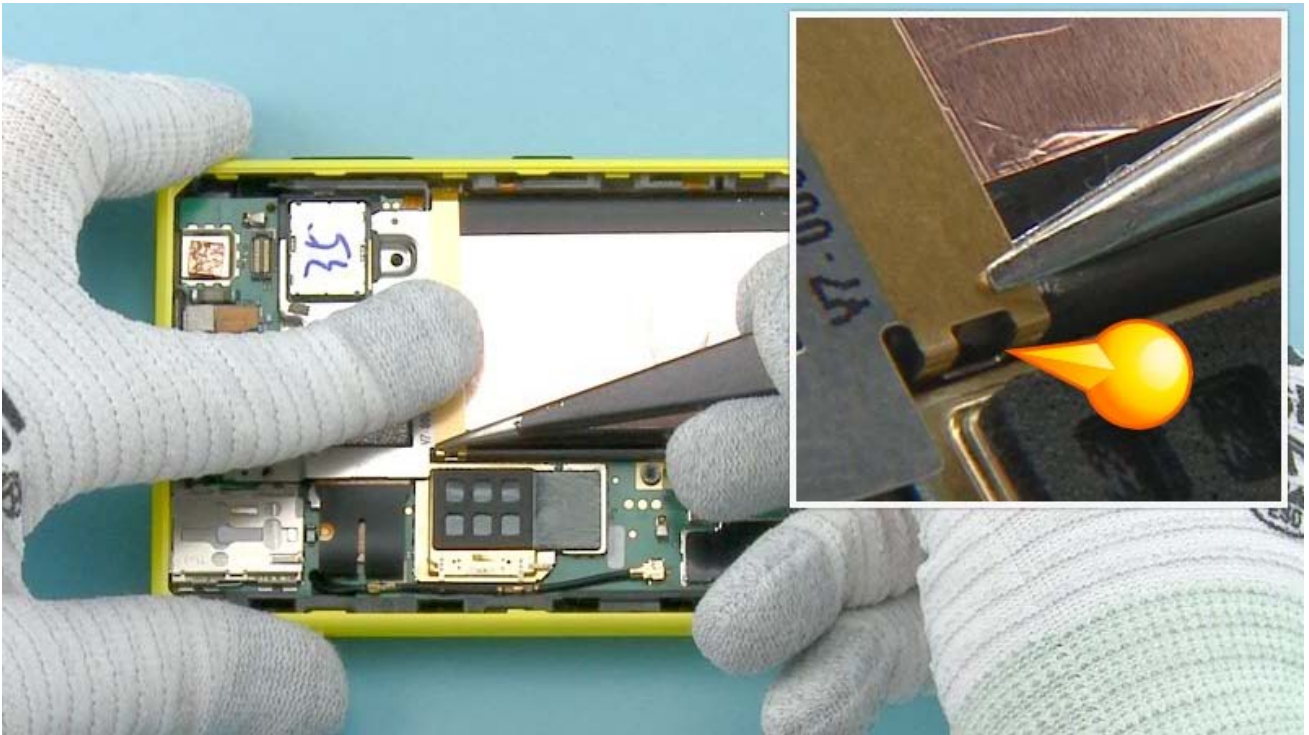

29) Secure the BATTERY HOLDER snaps.

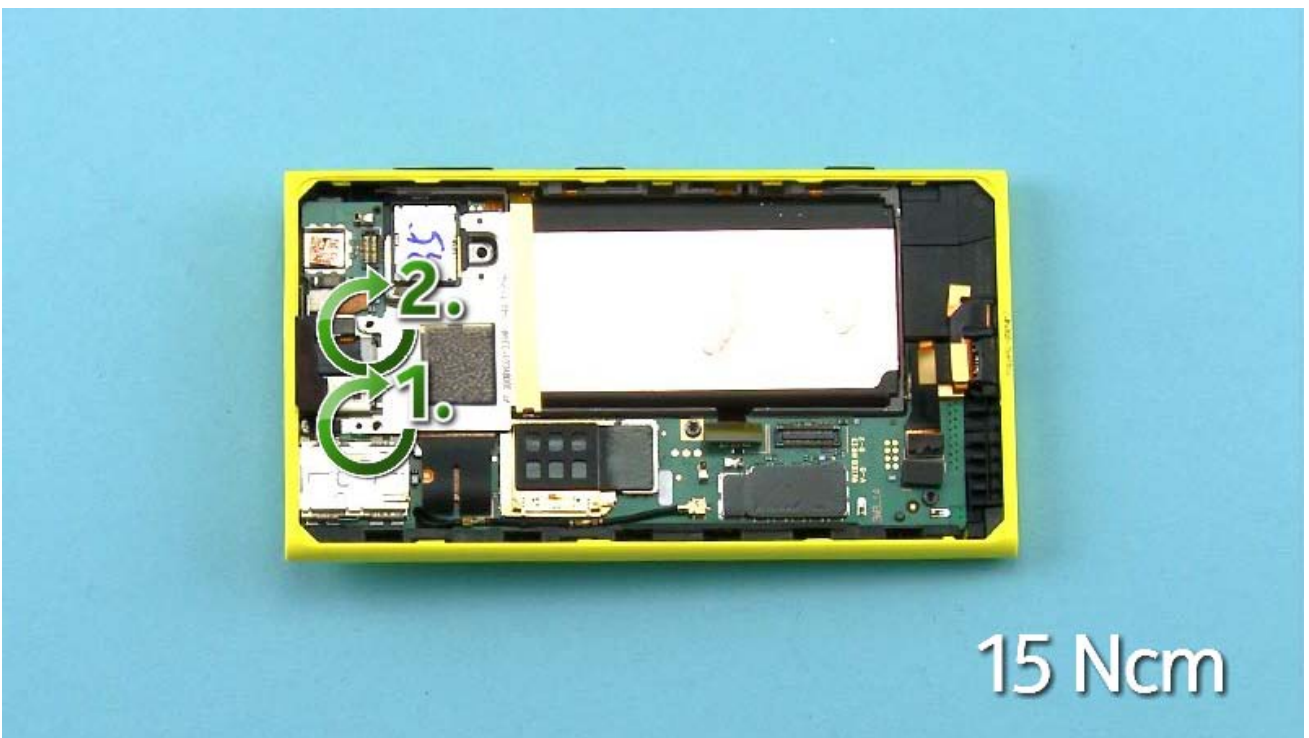

30) Fasten the two TORX+ size 5 screws in the order shown to the torque of 15 Ncm.

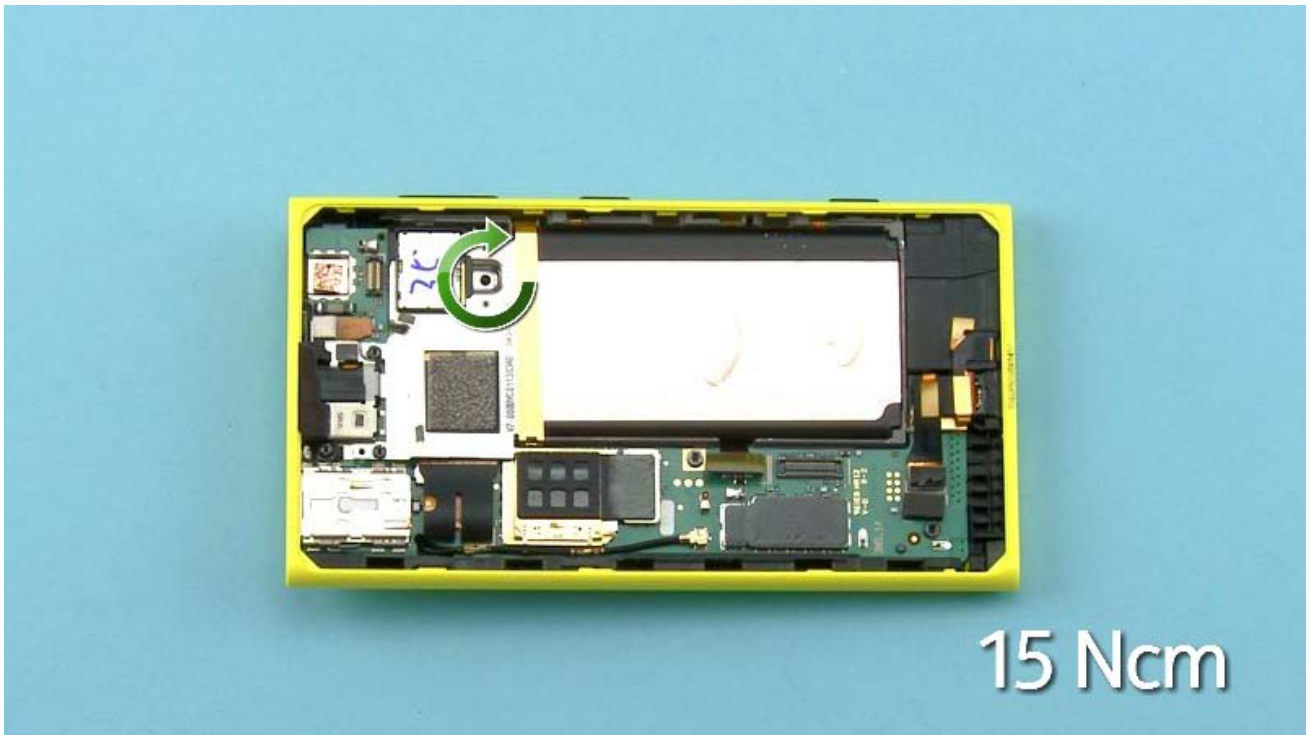

31) Fasten this TORX+ size 6 screw to the torque of 15 Ncm.

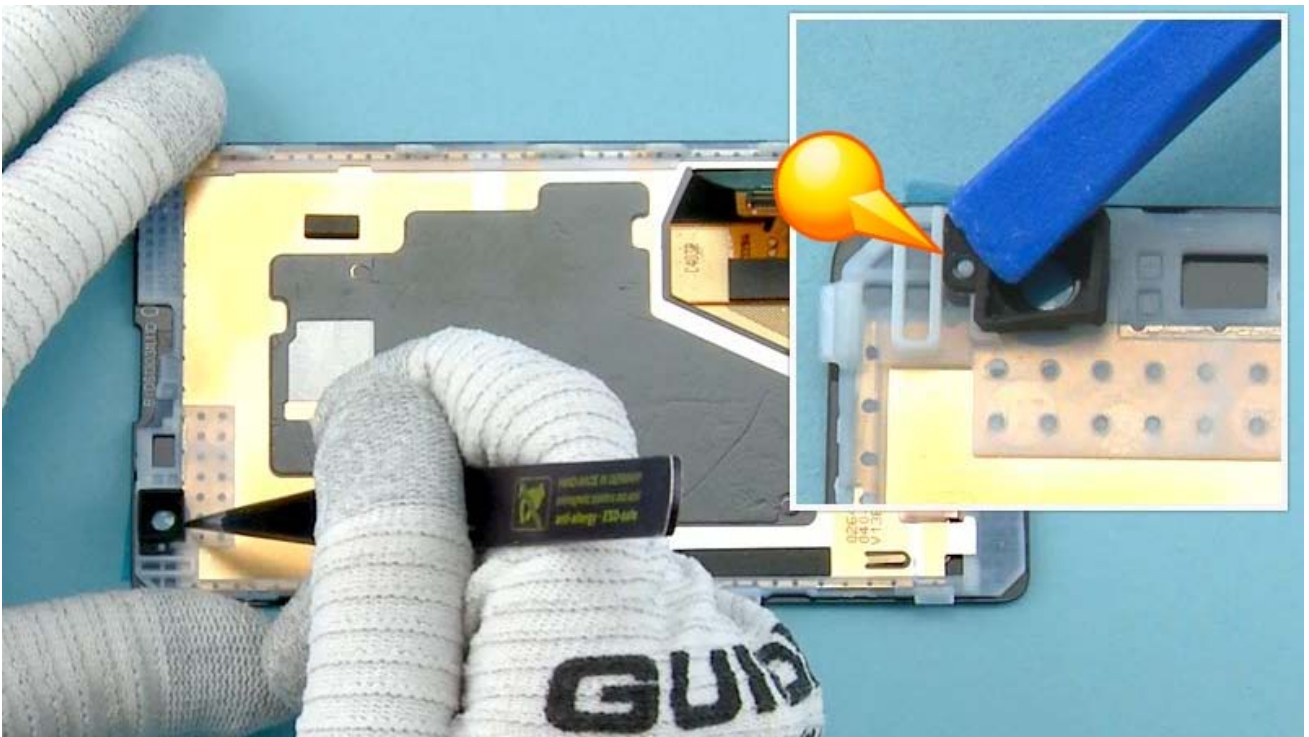

32) Place the 2nd CAMERA GASKET to the WINDOW ASSEMBLY.

NOTE: the alignment of the CAMERA GASKET.

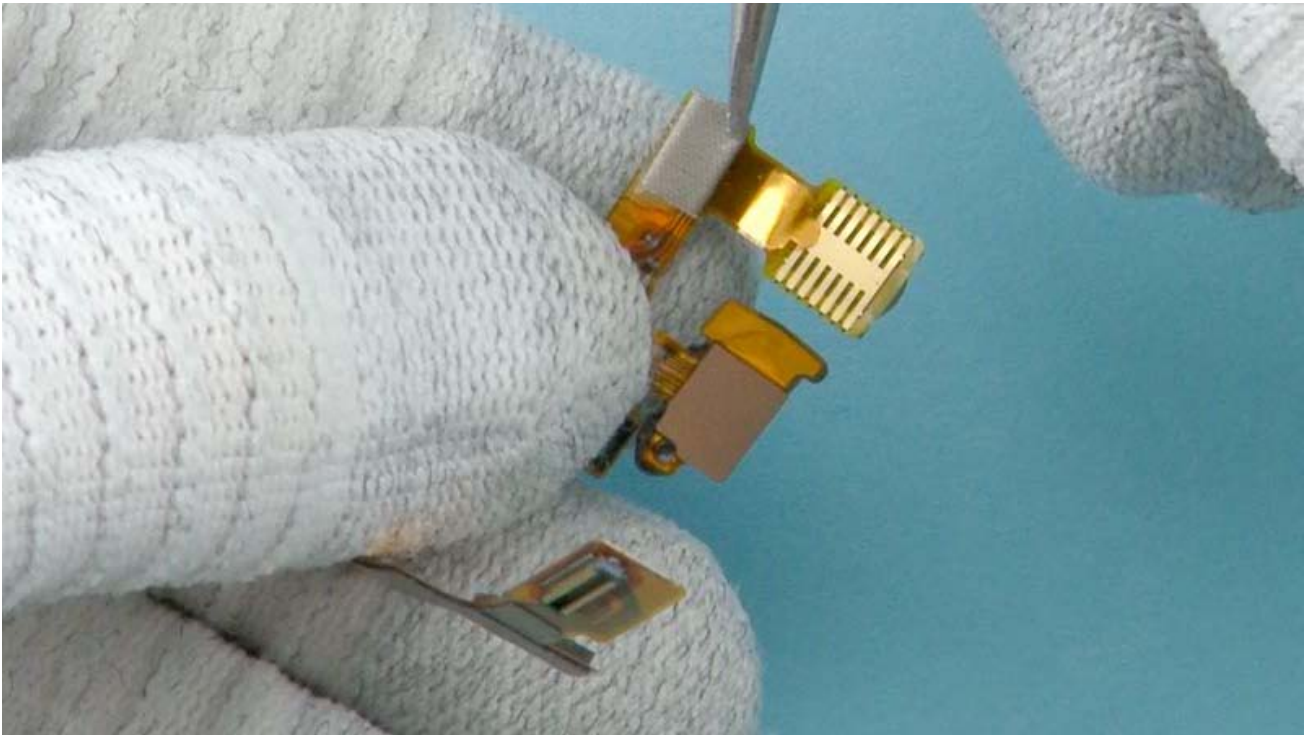

33) Place the 2nd CAMERA GROUNDING FOAM.

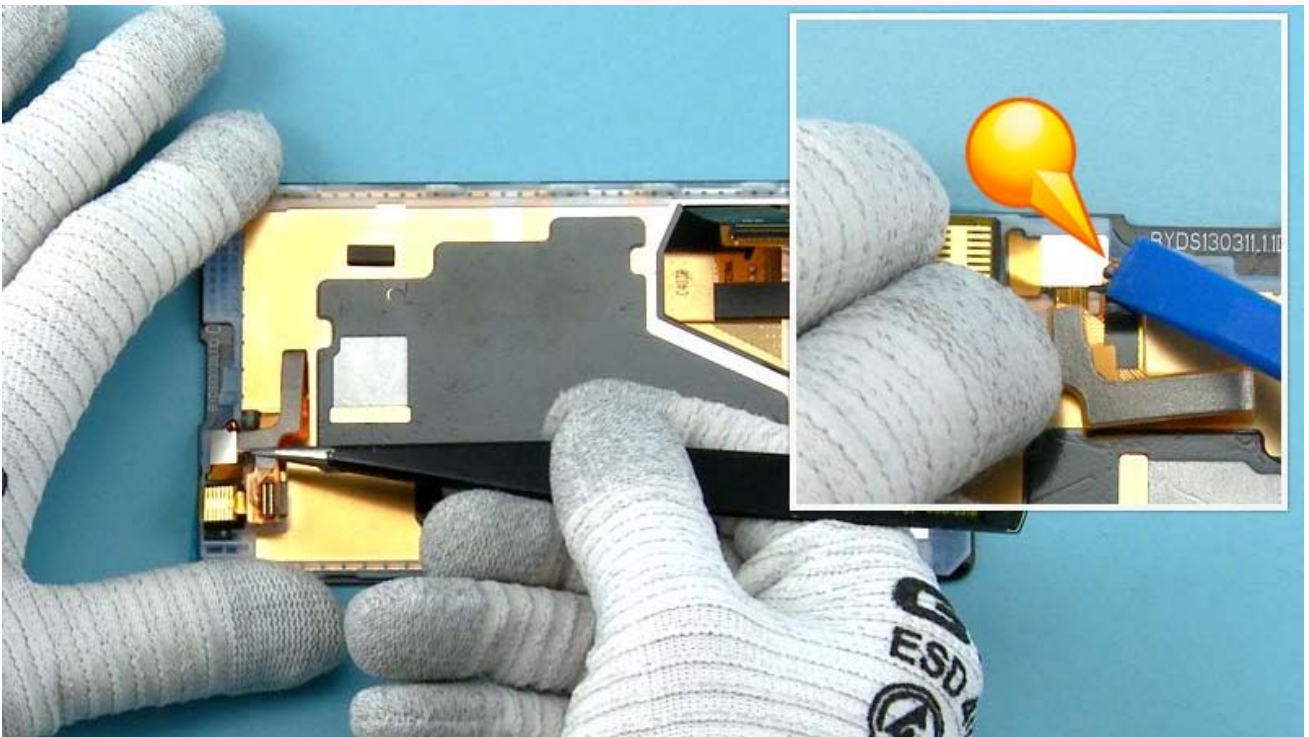

34) Use tweezers to align 2nd CAMERA ASSEMBLY into WINDOW ASSEMBLY. Make sure the 2nd CAMERA ASSEMBLY is aligned correctly. Secure the 2nd CAMERA GASKET with SS-93.



35) Use the SS-93 to connect the DISPLAY connector.

Be careful not to damage the connector or any nearby components.

NOTE: The connecting order of the connectors is mandatory to minimize the risk of battery current short circuits.



36) Use the SS-93 to connect the 2nd CAMERA FLEX CONNECTOR.

Be careful not to damage the connector or any nearby components.



37) Use the SS-93 to connect the BATTERY CONNECTOR.

Be careful not to damage the connector or any nearby components.



38) Align the shown side of the WINDOW ASSEMBLY to the BODY ASSEMBLY first.



39) Then put down the other side and press slightly to attach the WINDOW ASSEMBLY correctly.



40) Fasten the LOCKING RAIL TORX+ size 4 screw to the torque of 9 Ncm.

Tighten the screw very slowly and be careful not to break the LOCKING RAIL ASSEMBLY.



41) Place the SIM TRAY.



42) Press the power key and check that the device restarts properly.

The Nokia Lumia 1020 assembly procedure is complete.

-END OF ASSEMBLY-

## TOP

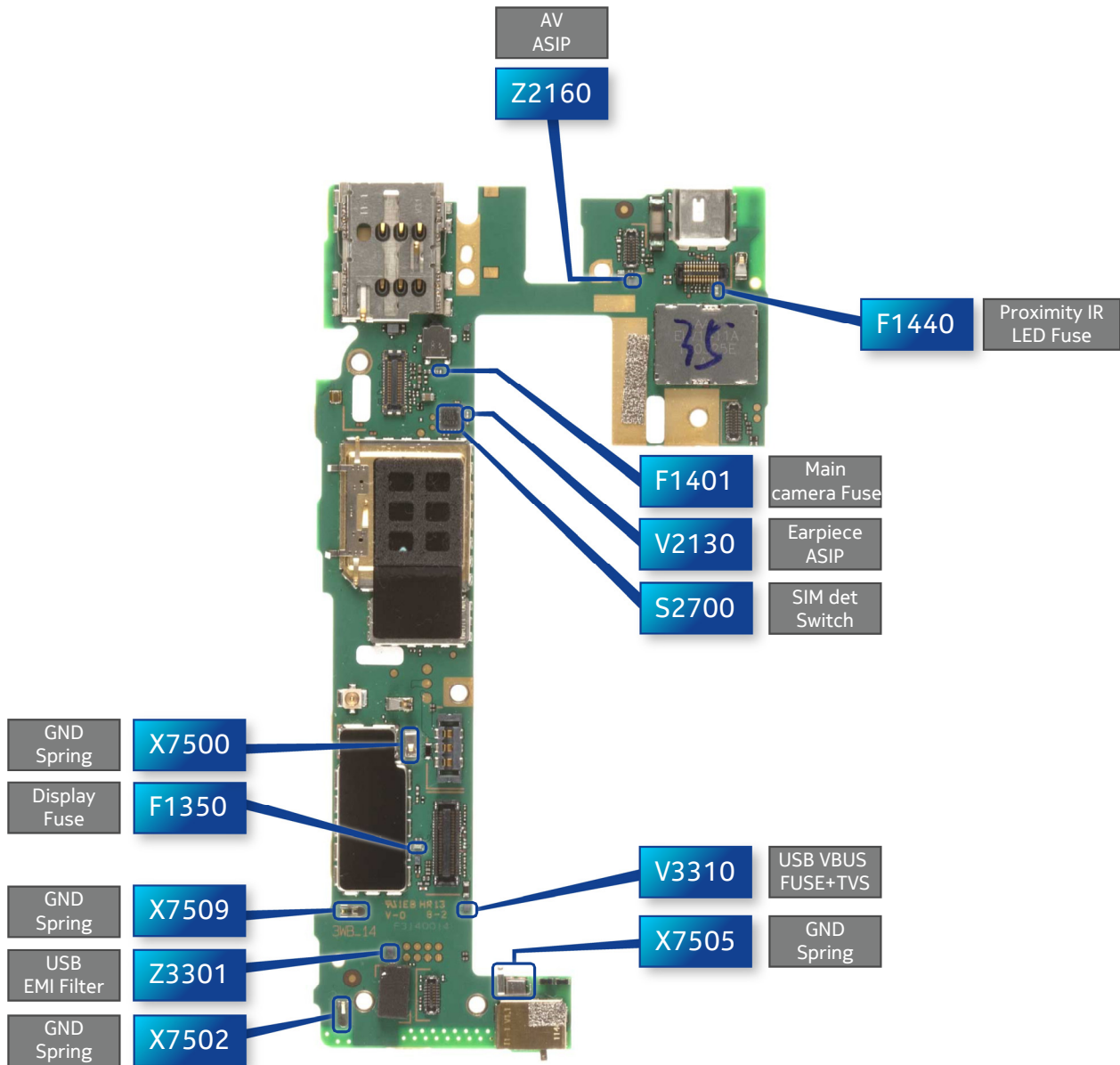



# BOTTOM

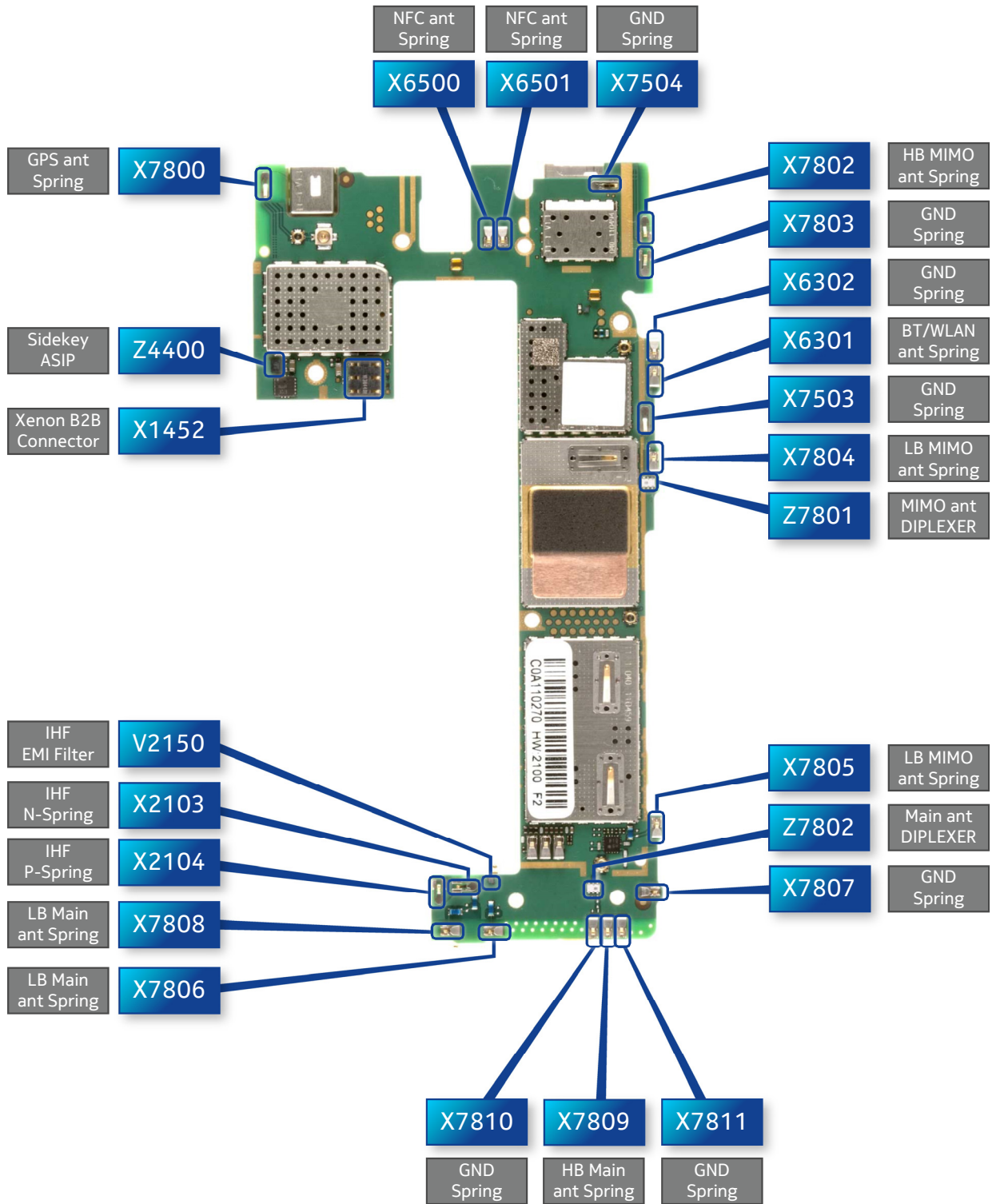



AC-60 Charger



CA-190CD Service cable



SIM door opening key



Nokia Standard Toolkit (v2)

For more information, refer to the Service Bulletin (SB-011) on Nokia Online. Supplier or manufacturer contacts for tool re-order can be found in "Recommended service equipment" document on Nokia Online.

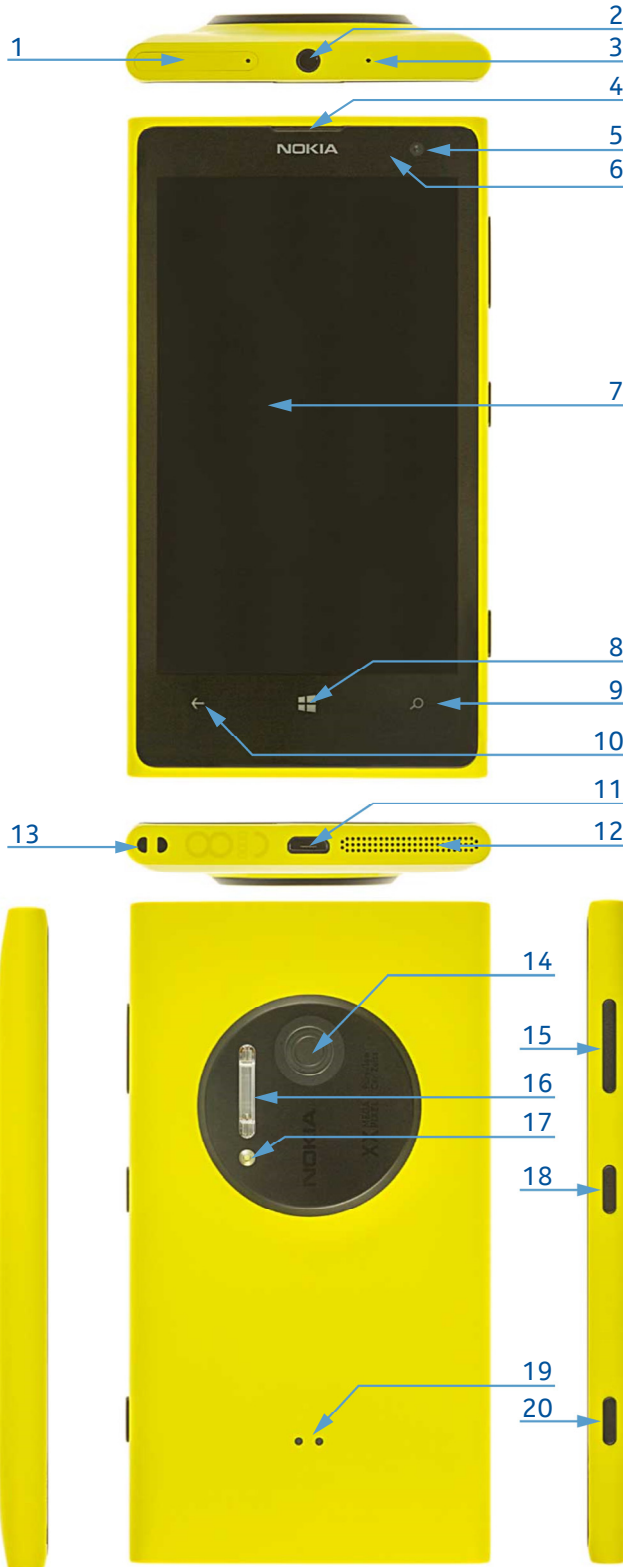

- 1 — Micro-SIM holder
- 2 — 3.5 mm headset connector
- 3 — Secondary microphone
- 4 — Earpiece
- 5 — Front camera
- 6 — Ambient light & proximity sensor
- 7 — Touch display
- 8 — Start key
- 9 — Search key
- 10 — Back key
- 11 — Micro-USB connector
- 12 — Loudspeaker
- 13 — Strap holder
- 14 — Main camera
- 15 — Volume keys
- 16 — Xenon flash
- 17 — Recording light
- 18 — Power/Lock key
- 19 — Wireless charging cover contacts
- 20 — Camera key
- 21 — Bluetooth & Wi-Fi antenna
- 22 — NFC area
- 23 — GPS antenna
- 24 — Cellular antennas



## Flashing concept

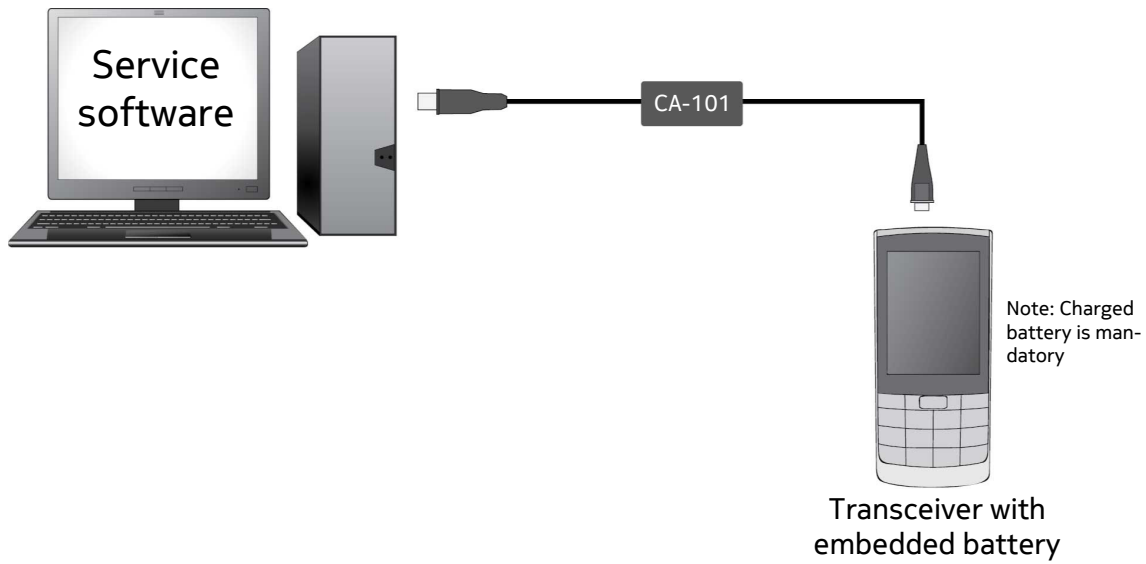

### Hardware reset

If the phone hardware is jammed, you should first recommend that the consumer performs a hardware reset. The hardware reset does not reset the Windows Live ID or remove any consumer data. Because the consumer cannot remove the battery to reset the phone the phone has a special electronic circuit which cuts the phone power when the volume down and power keys are pressed for 10-15 seconds.

To perform the hardware reset, press and hold the Volume down and Power keys at the same time for about 10-15 seconds until a short vibration is felt. The phone should restart by itself.



### Software / operating system (OS) reset

The software / operating system (OS) reset returns the phone to its out-of-the-box state. Note that this procedure erases all consumer data! Always first try to perform a hardware reset.

#### Option 1: About menu

- Use this option if the consumer knows the lock code
- This option warns the consumer about data loss!
- Tap **Settings > About > reset your phone**

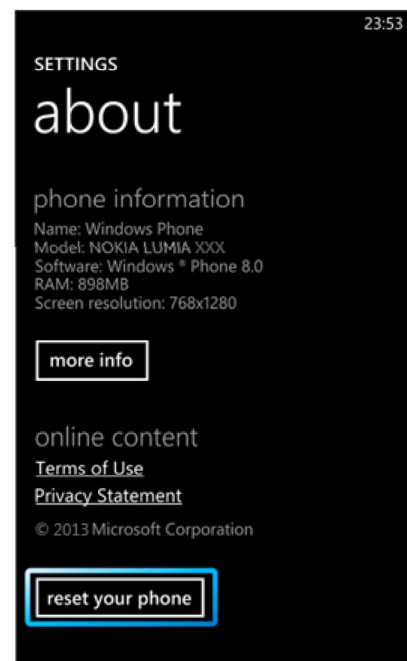

## Option 2: Hardware key combination

- Use this option if the phone is locked and the consumer does not know the code
- Note: no warning about data loss!
- Do not advertise this feature to consumers!

Follow next steps to perform OS reset with phone keys.

### Step 1

Make sure the phone is turned Off.

1. Press and hold the power key
2. Phone vibrates (release the power key)
3. Press and hold the volume down key
4. Exclamation mark is shown on the screen (release the volume down key)

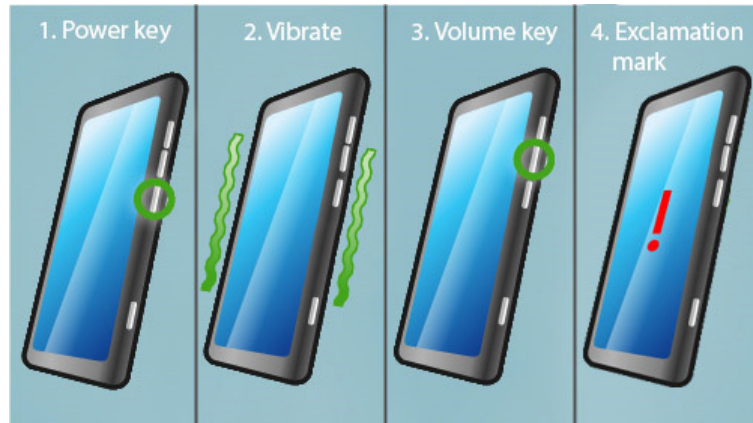

### Step 2

Input the following key combination:

1. Volume up
2. Volume down
3. Power
4. Volume down



### Step 3

The phone will reset and boot up automatically



Version	Date	Description
1.0	28.06.2013	First approved version
2.0	12.07.2013	First published version